

**EPSON® PowerLite® 7800p
Multimedia Projector**

User's Guide

Important Safety Information

WARNING: Never look into the projector lens when the lamp is turned on; the bright light can damage your eyes. Never let children look into the lens when it is on. Never open any cover on the projector, except the lamp and filter covers. Dangerous electrical voltages inside the projector can severely injure you. Except as specifically explained in this *User's Guide*, do not attempt to service this product yourself. Refer all servicing to qualified service personnel.

WARNING: The projector and its accessories come packaged in plastic bags. Keep plastic bags away from small children to avoid any risk of suffocation.

Caution: When you replace the lamp, never touch the new lamp with your bare hands; the invisible residue left by the oil on your hands may shorten the lamp life. Use a cloth or glove to handle the new lamp.

Copyright Notice

All rights reserved. No part of this publication may be reproduced, stored in a retrieval system, or transmitted in any form or by any means, electronic, mechanical, photocopying, recording, or otherwise, without the prior written permission of SEIKO EPSON CORPORATION. The information contained herein is designed only for use with this EPSON product. EPSON is not responsible for any use of this information as applied to other products.

Neither SEIKO EPSON CORPORATION nor its affiliates shall be liable to the purchaser of this product or third parties for damages, losses, costs, or expenses incurred by purchaser or third parties as a result of: accident, misuse, or abuse of this product or unauthorized modifications, repairs, or alterations to this product, or (excluding the U.S.) failure to strictly comply with SEIKO EPSON CORPORATION's operating and maintenance instructions.

SEIKO EPSON CORPORATION shall not be liable for any damages or problems arising from the use of any options or any consumable products other than those designated as Original EPSON Products or EPSON Approved Products by SEIKO EPSON CORPORATION.

EPSON is a registered trademark, and Quick Corner, and Wall Shot are trademarks of SEIKO EPSON CORPORATION.

EPSON Connection, EPSON Store, and Extra Care are service marks; SizeWise, EasyMP, and Easy Management are trademarks; and PrivateLine, Presenters Club, and PowerLite are registered trademarks of Epson America, Inc.

General Notice: Other product names used herein are for identification purposes only and may be trademarks of their respective owners. EPSON disclaims any and all rights in those marks.



C

Contents

<i>Welcome</i>	1
Using Your Documentation	2
Getting More Information	2
Registration and Warranty	3
Unpacking the Projector	4
Additional Components	5
Optional Accessories	6

1

<i>Setting Up the Projector</i>	7
Positioning the Projector	8
Connecting to Video Equipment	10
Connecting a Composite Video Source	11
Connecting an S-Video Source	12
Connecting a Component Video Source	13
Connecting an RGB Video Source	14
Connecting to a Computer	16
Connecting to the Computer Port	17
Connecting to the BNC Connectors	19
Connecting to the DVI Port	20
Using the Macintosh Desktop Adapter	21
Connecting the Cable for Remote Mouse Control	22
Connecting an External Monitor	23
Playing Sound Through the Projector	24
Connecting Audio Equipment to the Projector	24
Connecting External Speakers	25

2

<i>Displaying and Adjusting the Image</i>	27
Projecting the Image.	28
Turning on the Projector	28
Selecting the Image Source.	30
Troubleshooting Display Problems.	31
You Can't Project an Image	31
The Projector and Laptop Don't Display the Same Image.	31
Adjusting the Image	34
Focusing and Zooming Your Image.	34
Adjusting the Height of Your Image	35
Adjusting the Image Shape.	36
Correcting Computer Images.	39
Projecting Images Without a Screen.	40
Making Initial Color Corrections.	40
Adjusting Color Corrections for a New Surface	41
Enabling Password Protection	41
Starting the Projector with a Password.	42
Shutting Down the Projector	43

3

<i>Giving Your Presentation</i>	45
Activating and Using the Remote Control	46
Using the Navigation Buttons	47
Replacing the Batteries	48
Controlling the Picture and Sound.	49
Switching Between Picture Sources	49
Previewing Picture Sources	50
Turning Off the Picture and Sound	51
Stopping Action.	51
Zooming Your Image.	51
Displaying a Picture-in-Picture Video	52
Controlling the Volume.	53
Highlighting Your Presentation	54
Using the Pointer Tool	54
Customizing the Pointer Tools	55
Operating Your Computer with the Remote Control.	56

Creating Your Own Startup Screen	57
Capturing the Image	57
Choosing When to Display the Image	59
Controlling Multiple Projectors	60
Setting the Projector ID	60
Setting the Remote Control ID	61

4

<i>Fine-tuning the Projector</i>	63
Using the Menu System	64
Restoring the Default Settings	65
Adjusting the Image Quality	66
Adjusting Images from Video Sources	66
Adjusting Computer Images	67
Adjusting the Image Size, Shape, and Position	69
Adjusting the Color	70
Adjusting the Sound	71
Customizing Projector Features	72
Image Setup Options	72
Communication Setup Options	73
Miscellaneous Setup Options	74

5

<i>Managing the Projector from a Remote Computer</i>	75
Installing the Easy Management Software	76
System Requirements	76
Installing the Software	76
Connecting and Configuring the Projector	78
Using EMP Monitor	80
Opening and Closing EMP Monitor	80
Registering a Projector	81
Monitoring Your Projectors	83
Controlling Your Projectors	85
Configuring the Monitoring Interval	86

Using EMP NetworkManager	87
Selecting the Projectors to Monitor	87
Setting a Password	88
Creating the E-Mail Settings	88
Understanding the Notification Messages	91

6

<i>Maintaining the Projector</i>	93
Cleaning the Lens	94
Cleaning the Projector Case	94
Cleaning the Air Filters and Vents	95
Replacing the Lamp and Air Filters	96
Resetting the Lamp Timer	99
Transporting the Projector	100

7

<i>Solving Problems</i>	101
Using On-Screen Help	102
Checking Projector Status	103
What To Do When the Lights Flash	103
Viewing Lamp Usage and Other Information	105
Solving Problems with the Image or Sound	106
Solving Easy Management Problems	112
Solving Problems with the Remote Control	112
Where To Get Help	113
Telephone Support Services	113

A

<i>Appendix A: Projector Installation</i>	115
Installation Guidelines	115

B

<i>Appendix B: Technical Specifications</i>	117
---	-----

C *Appendix C: Notices*..... 123
Important Safety Instructions 123
Remote Control Information 125
Declaration of Conformity 126
FCC Compliance Statement 127
Warranty 128

Index..... 131

W

Welcome

The EPSON® PowerLite® 7800p is a versatile, lightweight projector designed to ensure that your presentations are easy and trouble-free, whether you use it in the classroom or conference room. When space is limited, you can project against a surface less than five and one-half feet away. The projector's keystone correction function automatically corrects image distortion, and EPSON's unique Wall Shot™ function lets you project against blackboards and colored walls without loss of image color, regardless of ambient lighting. In addition, the PowerLite 7800p offers outstanding image quality, with up to 3500 lumens of brightness, a resolution of 1024 × 768 pixels, and a 700:1 contrast ratio.

Connectivity

Your EPSON PowerLite projector can be connected to three computers at the same time, or four video sources (up to a total of five sources at the same time). You can include an independent sound channel for each source. A preview feature lets you see all the sources at a glance, so you can easily switch between them.

Complete control

Use the remote control to take charge of your presentation. Freeze the action, zoom in on part of the picture, or display a picture-in-picture video. Use the remote as a pointer, or to draw on the screen. You can even use it in place of your computer's mouse to control your computer and change slides in PowerPoint.®

Easy Management

With the projector's Easy Management™ system, you can use a Windows® PC to remotely monitor and control the projector.

Security

To discourage theft, you can assign the projector a password, thus preventing unauthorized persons from using it.

Using Your Documentation

This book contains all the information you need to set up and use your projector. Please follow these guidelines as you read through it:

- Warnings must be followed carefully to avoid bodily injury.
- Cautions must be observed to avoid damage to your equipment.
- Notes contain important information about your projector.
- Tips contain additional projection hints.

Getting More Information

Need tips on giving presentations? Quick steps for setting up your projector? Here's where you can look for help:

- **presentersonline.com**
Includes a library of articles covering presentation tips, tricks, and technology. The site provides templates, clip art and sound clips, as well as Presenters Services to use on the road. Even more resources and services are available if you register to join the Presenters Club®—and it's free.
- **Quick Setup sheet**
Gives you the instructions you need to get your projector up and running if you are connecting to a laptop, PowerBook®, or iBook® computer.
- **Start Here kit**
Includes this *User's Guide*, your *Quick Setup* sheet, warranty brochures, and EPSON PrivateLine® Support card. Keep the folder with your projector at all times.
- **Built-in help system**
Provides assistance for common problems. Available from the **Help** button on the projector or the remote control. See page 102 for details.
- **support.epson.com**
Download FAQs and e-mail your questions to EPSON support.

need help?

If you still need help after checking this User's Guide and the sources listed to the right, you can use the EPSON PrivateLine Support service to get help fast. Call (800) 637-7661 and enter the PIN on the card in your Start Here kit. Or take advantage of EPSON's automated support services 24 hours a day. See page 113 for more information.

Registration and Warranty

Your projector comes with a basic carry-in warranty as well as an international warranty that let you project with confidence anywhere in the world. For details, see page 128 and the warranty brochure included in your Start Here kit.

In addition, for customers who register their projector, EPSON offers free Extra CareSM Road Service. In the unlikely event of an equipment failure, you won't have to wait for your unit to be repaired. Instead, EPSON will ship you a replacement unit anywhere in the United States or Canada, usually via overnight delivery. See the brochure in your Start Here kit for details.

To register, simply fill out the registration card included in your Start Here kit and mail it to EPSON. Or you can register online at <http://epsonwebreg.info2.net/>. Registering also lets you receive special updates on new accessories, products, and service.

Unpacking the Projector

After unpacking the projector, make sure you have all the parts shown below:

note

You won't need all these components; your configuration will determine which ones you need.

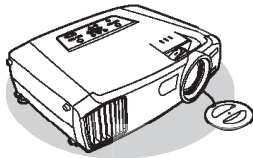

Projector



Remote control and batteries



Projector software CD-ROM

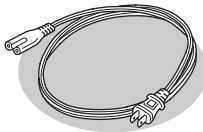

Power cable

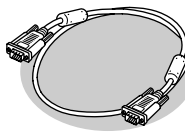

VGA computer cable

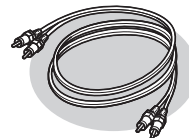

RCA-style audio cable

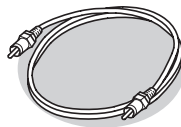

RCA-style video cable



Stereo mini-jack audio cable

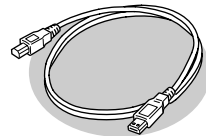

USB cable

Save all packaging in case you need to ship the projector. Always use the original packaging (or the equivalent) when you need to send the projector to another location. If you are moving the projector by hand, use a carrying case (either an EPSON case or something similar, such as a laptop case). See page 6 for ordering information, and page 100 for transportation instructions.

Additional Components

Depending on how you plan to use the projector, you may need additional components:

- To receive an S-Video signal, you'll need an S-Video cable. One may be provided with your video equipment, or you can purchase one from EPSON; see page 6.
- To receive a component video signal from a VCR or other video device, you'll need a component video cable.
- To project HDTV images, you'll need an HDTV cable.
- Some older PowerBooks and Macintosh® desktop models may need the Macintosh adapter set shown on page 21 (available from EPSON; see page 6). Older iMac® systems may need a special adapter to provide a VGA output port; see your computer dealer.

Optional Accessories

To enhance your use of the projector, EPSON provides the following optional accessories:

Product	Part number
Replacement lamp	V13H010L22
Air filter replacement set	V13H134A01
Samsonite® wheeled soft case ATA molded hardshell case	ELPKS35 ELPKS48
Ceiling mount Suspension adapter False ceiling plate	ELPMB40 ELPMBAPL ELPMBFCP
Optional lenses*	See below
Kensington® security lock	ELPSL01
Projection screens: 50-inch portable screen 60-inch portable pop-up screen 80-inch portable pop-up screen	ELPSC06 ELPSC07 ELPSC08
Macintosh adapter set (includes monitor adapter and desktop adapter)	ELPAP01
Remote control cable set	V12H005C28
DVI to DVI digital video cable, 10 ft. DVI to DFP digital video cable, 10 ft. S-Video cable Component video cable, 10 ft.	ELPKC20 ELPKC21 ELPSV01 ELPKC19
Distribution amplifier	ELPDA01
High resolution document imager Motion presentation camera High resolution document camera	ELPDC02 ELPDC03 V12H064020

* Visit the EPSON Store or contact your dealer for part numbers.

You can purchase these accessories from your dealer, by calling EPSON at (800) 873-7766, or by visiting the EPSON StoreSM at www.epsonstore.com (U.S. sales only). In Canada, please call (800) 463-7766 for dealer referral.

1 *Setting Up the Projector*

This chapter gives you basic information on setting up the projector: where to position it and how to connect it to a video source (such as a VCR or DVD player) or to a laptop or desktop computer.

Follow the instructions in this chapter on:

- Positioning the projector
- Connecting to video equipment
- Connecting to a computer
- Connecting an external monitor
- Playing sound through the projector

note

You can mount the projector on the ceiling, or place it behind a translucent screen for rear projection. See page 115 for details.

Positioning the Projector

If you're setting up the projector yourself and it isn't already installed in the theater or conference room you're using, you'll probably want to place it on a table in front of the screen, as shown.

This lets you stand in the front of the room, face the audience, and remain close enough to the equipment to be able to control it. Try to leave as much space as possible between the projector and the screen to get a good-size image.

Use the figure below to help you determine placement. Image size increases with distance, but can vary depending on how you position the zoom ring and whether you've adjusted the image with other settings.

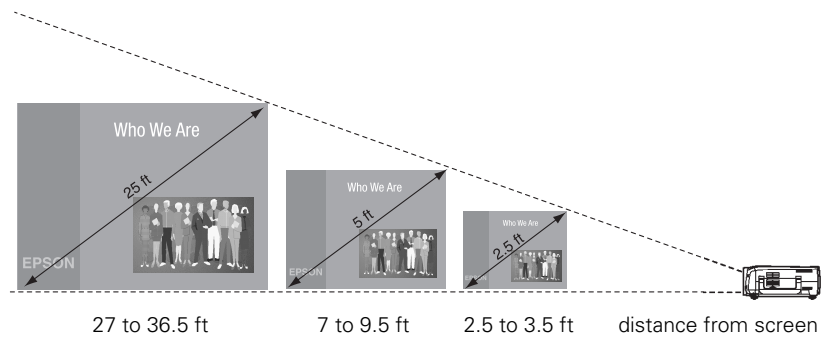

Also keep these considerations in mind:

- Place the projector on a sturdy, level surface.
- Make sure there is plenty of space for ventilation around and under the projector. Do not set the projector on top of loose papers that could block the vents under the projector.
- Make sure the projector is within 10 feet of a grounded electrical outlet or extension cord.

Ideally, you should place the projector directly in front of the center of the screen, facing it toward the screen squarely. The base of the lens should be at about the level of the bottom of the screen.

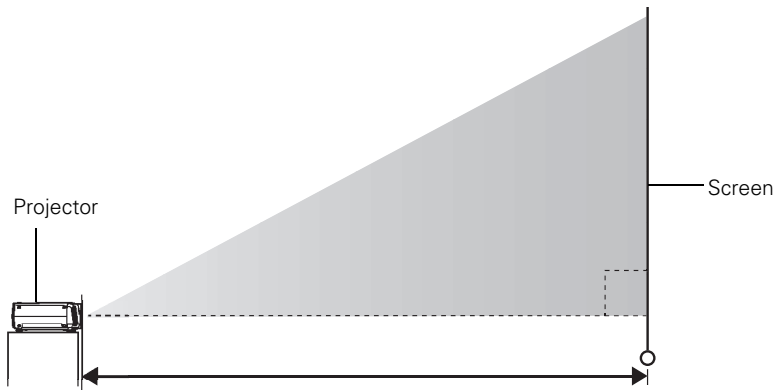

If you place the projector below screen level, you'll have to tilt it up by extending its feet. This causes the image to become “keystone” shaped, but you can correct the distortion by pressing the **Sync** buttons on the projector. See page 36 for detailed information about correcting the image shape.

For instructions on installing the projector in a permanent location, such as a theater or conference room, see page 115.

note

After positioning the projector, you may want to connect a Kensington MicroSaver® anti-theft device to the lock port on the projector's left side. You can purchase this from EPSON; see “Optional Accessories” on page 6.

Connecting to Video Equipment

You can connect up to four video sources to the projector at the same time. Before starting, look at your video equipment to determine its available video-output connections:

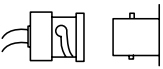

- If your video player has a yellow RCA-style video output connector, see “Connecting a Composite Video Source” on page 11.
- If your video player has an S-Video connector, see “Connecting an S-Video Source” on page 12.
- If your video player has a component video port (three connectors labeled either Y/Cb/Cr or Y/Pb/Pr), see “Connecting a Component Video Source” on page 13.
- If your video player has an RGB video port (either a single connector for a VGA-style monitor cable, or three connectors labeled R/G/B), see “Connecting an RGB Video Source” on page 14.

After connecting any video cables, you may also want to:

- connect a monitor to the projector so you can view your presentation close-up as well as on-screen; see page 23
- connect an audio cable to play sound through the projector; see page 24

Connecting a Composite Video Source

1. Locate the RCA-style video cable provided with the projector.
2. Connect the cable to the yellow video output connector on your player and the yellow **Video** connector on the projector:

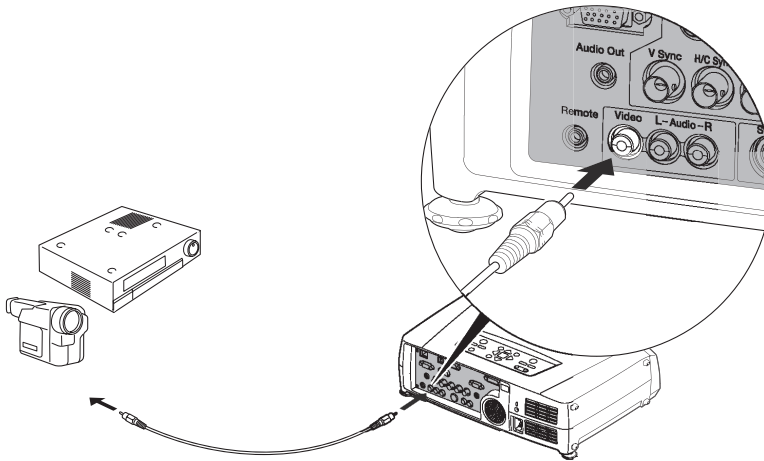

3. If you want to play sound through the projector, see page 24 for instructions on connecting an audio cable.
4. If you don't need to make any other connections, see Chapter 2 or the *Quick Setup* sheet for instructions on turning on the projector and adjusting the image. Once the projector is turned on, select the image source: press the **Video** button on the remote control, or press the **Video/BNC** button on the projector's control panel repeatedly until **Video** is displayed on the projected image.

Connecting an S-Video Source

1. Locate an S-Video cable (one is usually provided with your video equipment, or you can purchase one from EPSON; see page 6).
2. Connect the cable between the S-Video connector on your player and the S-Video connector on the projector:

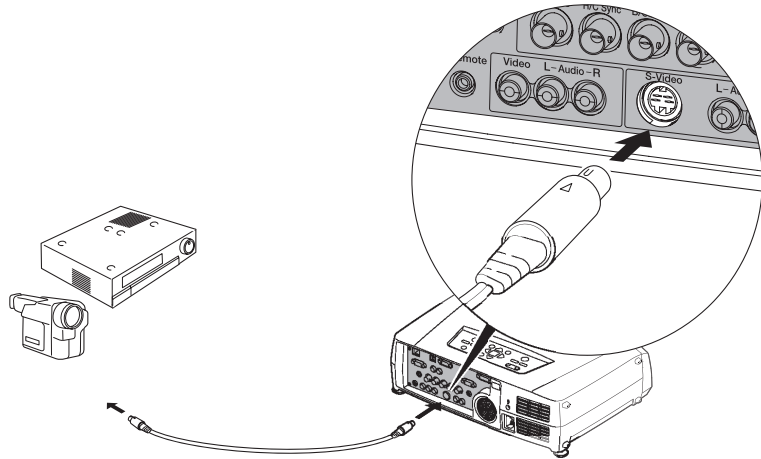

3. If you want to play sound through the projector, see page 24 for instructions on connecting an audio cable.
4. If you don't need to make any other connections, see Chapter 2 or the *Quick Setup* sheet for instructions on turning on the projector and adjusting the image. Once the projector is turned on, select the image source: press the **S-Video** button on the remote control, or press the **Video/BNC** button on the projector's control panel repeatedly until **S-Video** is displayed on the projected image.

Connecting a Component Video Source

1. Locate a component video cable (one may be included with your video equipment).

Look at the connectors at one end of the cable. If they are bayonet-style (BNC) connectors, continue on to the next step. If they are RCA-style connectors, you'll need to attach commercially available BNC adapters to plug the cable into your projector.

2. Connect the cable (with the adapters) to your player and the BNC connectors on the projector. Match the Y/Cb/Cr (or Y/Pb/Pr) connectors on your player to the corresponding connectors on the projector.

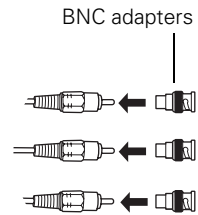
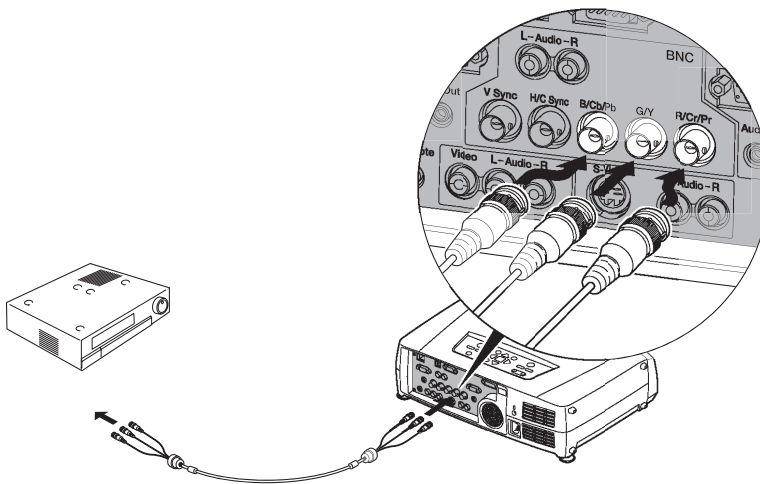

note

Be sure your video player is not an RGB video source. If you set the wrong source, image quality may suffer. Check your video player's documentation.

3. If you want to play sound through the projector, see page 24 for instructions on connecting an audio cable.
4. If you don't need to make any other connections, see Chapter 2 for instructions on turning on the projector and adjusting the image. Once the projector is turned on, do the following:
 - Enter the projector's Setting menu, then change the BNC Input setting to YCbCr or YPbPr, as needed (see page 72).
 - After exiting the menu system, press the remote control's BNC button or repeatedly press the projector's Video/BNC button to select BNC as the image source.

note

Be sure your video player is not a component video source. If you set the wrong source, image quality may suffer. Check your video player's documentation.

Connecting an RGB Video Source

Follow these instructions to connect the projector to a video player that has an RGB video output port. Depending on the type of connector on your player, you'll need to use the appropriate cable:

- If your player has a single VGA-style connector, see below.
- If your player has three connectors labeled R/G/B, see “Connecting Using a BNC-style Cable” on page 15.

Connecting Using a VGA-style Computer Cable

1. Locate the VGA computer cable provided with the projector.
2. Connect the cable between the video port on your player and the Computer port on the projector.

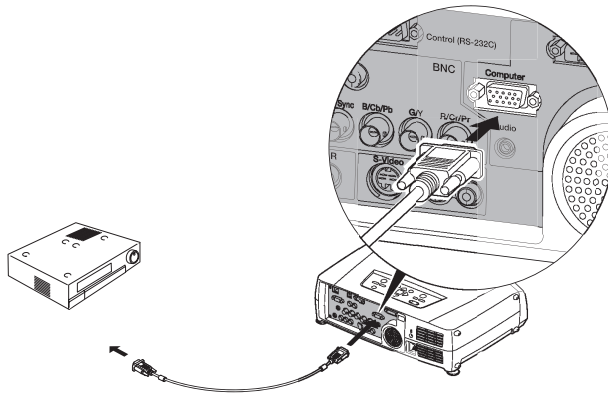

3. If you want to play sound through the projector, see page 24 for instructions on connecting an audio cable.
4. If you don't need to make any other connections, see Chapter 2 for instructions on turning on the projector and adjusting the image. Once the projector is turned on, be sure to:
 - Enter the projector's Setting menu, then change the Computer Input setting to **RGB-Video** (see page 72).
 - After exiting the menu system, press the remote control's **Comp** button or the projector's **Computer/DVI** button repeatedly to select the image source. (**Computer (RGB Video)** should appear on the screen.)

Connecting Using a BNC-style Cable

1. Locate a BNC-style video cable (one may be included with your video equipment).
2. Connect the cable between your player and the corresponding R/G/B connectors on the projector.

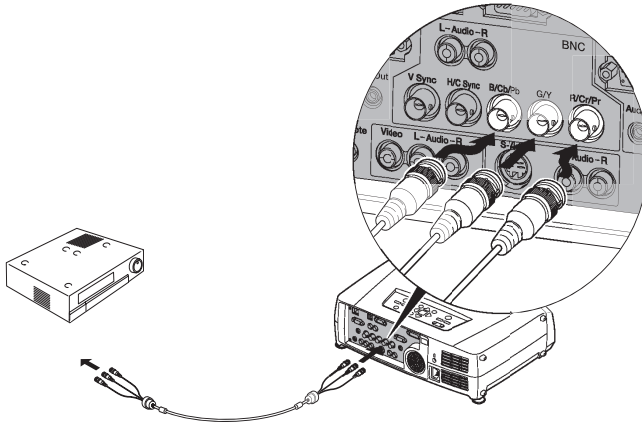

3. If you want to play sound through the projector, see page 24 for instructions on connecting an audio cable.
4. If you don't need to make any other connections, see Chapter 2 or the *Quick Setup* sheet for instructions on turning on the projector and adjusting the image. Once the projector is turned on, be sure to:
 - Enter the projector's Setting menu, then change the BNC Input setting to **RGB-Video** (see page 72).
 - After exiting the menu system, press the **BNC** button on the remote control or press the **Video/BNC** button on the projector repeatedly to select the correct image source (**BNC (RGB-Video)** should appear on the screen).

note

Be sure your video player is not a component video source. If you set the wrong source, image quality may suffer. Check your video player's documentation.

Connecting to a Computer

note

*If you connect a Windows-based computer to the projector, you may see a New Hardware Wizard saying your computer has found a plug-and-play monitor; if so, click **Cancel**.*

You can connect the PowerLite projector to any computer that has a standard video output (monitor) port, including desktop models, PC notebook and laptop computers, Macintosh PowerBooks and iBooks, and hand-held devices. You can connect up to three computers at the same time:

- To connect to the **Computer** port (standard VGA cable connection), see page 17.
- To connect using the **BNC** ports, see page 19.
- To connect using the **DVI** (Digital Video Interface) port, see page 20.

After connecting to the computer, you may also want to:

- connect a **USB** cable so you can use the remote control as a mouse; see page 22
- connect a **monitor** to the projector so you can view your presentation close-up as well as on-screen (not necessary if you're using a laptop); see page 23
- connect an **audio** cable to play computer audio; see page 24

Connecting to the Computer Port

Follow these instructions:

1. You can connect to the Computer port in three ways:
 - using the VGA computer cable that came with the projector (the monitor port on your computer must be a mini D-sub 15-pin port)
 - using a commercially available 13w3 D-sub 15-pin cable, if your computer has a 13w3 monitor port
 - using the optional BNC/VGA component video cable, if your computer provides video output through BNC connectors (see “Optional Accessories” on page 6).
2. If you’re using the VGA computer cable, connect one end to the projector’s Computer port, and the other end to your computer’s monitor port. Then go to step 4.

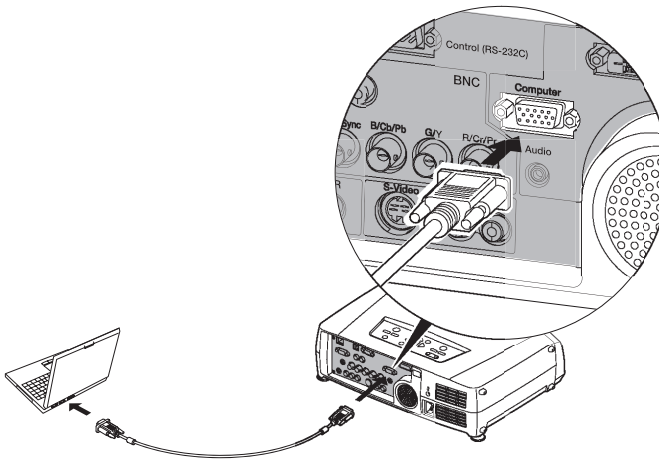

caution

Don't try to force a connector to fit a port with a different shape or number of pins. You may damage the port or connector.

VGA computer cable



BNC/VGA cable



note

If you're using a PowerBook or an older Macintosh and you can't connect the cable to your computer, you may need to use the Macintosh desktop adapter as shown on page 21 (available from EPSON; see page 6).

3. If you're using the optional BNC/VGA cable, connect the VGA connector to the projector's **Computer** port and plug the BNC connectors into your computer's monitor ports.

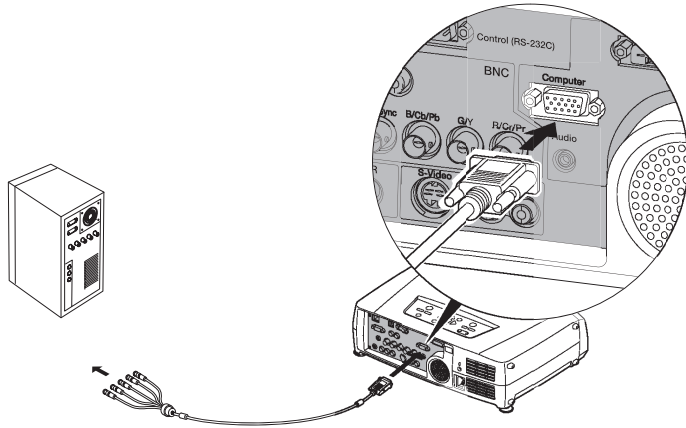

4. Optionally, you can connect an external monitor (see page 23), play sound through the projector (see page 24), or connect a USB cable to use the remote control as a mouse (see page 22).
5. When you've finished making any connections, see Chapter 2 for instructions on turning on the projector and adjusting the image. Once the projector is turned on, be sure to:
 - Enter the projector's Setting menu, then make sure Computer Input is set to **Analog-RGB**. See page 72.
 - After exiting the menu system, press the remote control's **Comp1** button, or repeatedly press the **Computer/DVI** button on the projector's control panel to select the correct source (**Computer (Analog-RGB)** should appear on the screen).

Connecting to the BNC Connectors

1. Obtain a commercially available standard BNC cable.
2. Plug the BNC connectors into the projector's B/Cb/Pb, G/Y, and R/Cr/Pr connectors as shown below. Depending on your computer's video card, you may have to connect to the projector's V Sync and H/C Sync connectors too. (See your computer documentation for more information.)

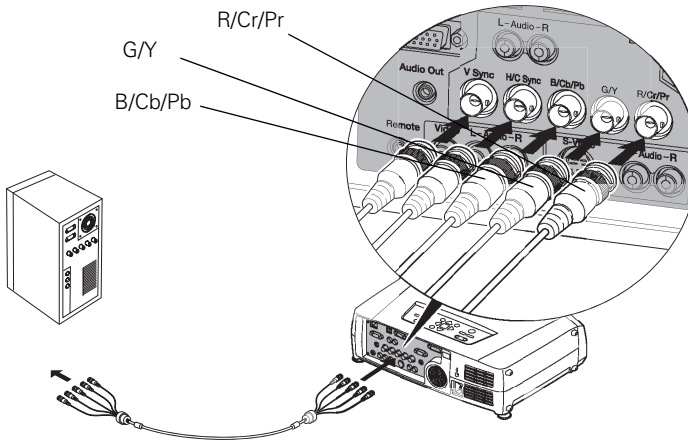
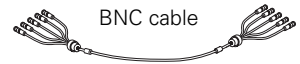

3. Plug the connectors on the other end of the cable into the BNC video out connectors on your computer.
4. Optionally, you can connect an external monitor (see page 23), play sound through the projector (see page 24), or connect a USB cable to use the remote control as a mouse (see page 22).
5. When you've finished making any connections, see Chapter 2 for instructions on turning on the projector and adjusting the image. Once the projector is turned on, be sure to:
 - Enter the projector's Setting menu, then make sure the BNC Input is set to **Analog-RGB**. See page 72.
 - After exiting the menu system, press the **BNC** button on the remote control or repeatedly press the **Video/BNC** button on the projector's control panel to select the correct source (BNC (Analog-RGB) should appear on the screen).

Connecting to the DVI Port

note

Various types of DVI cables are offered on the market. Be sure to use only a cable with DVI to DVI or DVI to DFP connectors.

1. Obtain a DVI digital video cable (either DVI to DVI or DVI to DFP; see page 6 for details about ordering a cable from EPSON).
2. Connect the cable to the projector's DVI port as shown.

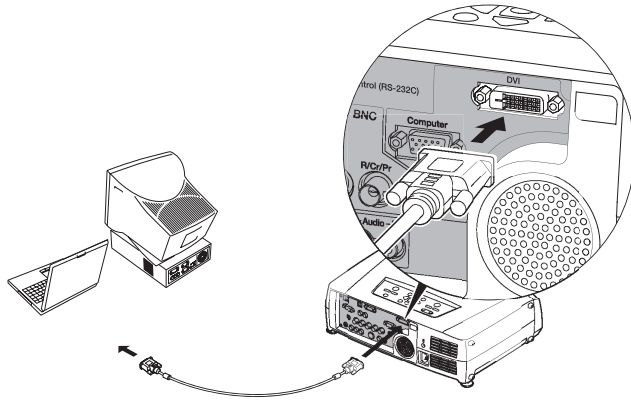

3. Connect the other end to your computer's DVI port.
4. Optionally, you can connect an external monitor (see page 23), play sound through the projector (see page 24), or connect a USB cable to use the remote control as a mouse (see page 22).
5. When you've finished making any connections, see Chapter 2 for instructions on turning on the projector and adjusting the image. Once the projector is turned on, press the DVI button on the remote control, or press the **Computer/DVI** button on the projector's control panel to select DVI as the image source.

Using the Macintosh Desktop Adapter

If you have an older desktop Macintosh or PowerBook, the VGA cable may not fit when you try to connect it. If so, you'll need to use the Macintosh desktop adapter to connect the VGA cable to your computer. This is available from EPSON (see page 6).

1. To use the adapter, remove its cover as shown and set its DIP switches according to the resolution you want to use, such as 16-inch mode. See your Macintosh documentation for instructions.

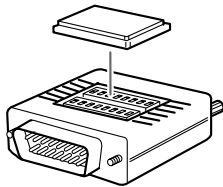

2. Replace the cover and connect the adapter to the VGA cable. Then plug the cable (with the adapter) into the video port on your Macintosh.
3. Tighten the screws on the connectors.

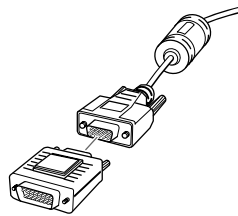

Connecting the Cable for Remote Mouse Control

If you've connected a computer as described in this chapter, you can use the projector's remote control as a wireless mouse. This lets you control your computer and click through slideshow-style presentations, such as PowerPoint, from up to 30 feet away.

note

The remote mouse control function may not operate correctly on systems that have been upgraded from an earlier version of Windows.

The wireless mouse function is supported on systems with a USB port running Windows XP, 98, 2000, or Me, or Macintosh OS 8.6 to OS X 10.2.

1. Locate the USB cable that came with your projector.
2. Connect the square end of the cable to the projector's  USB port.

note

For details on using the remote control in place of your computer's mouse, see page 56.

Use to move cursor

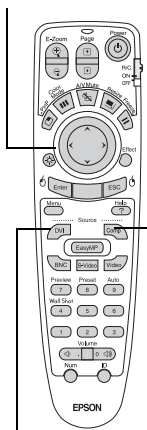

Left-click Right-click

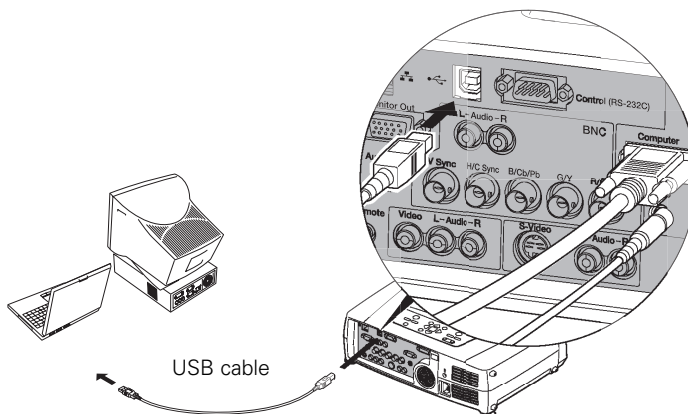

3. Connect the flat end of the cable to any available USB port on your laptop or desktop computer.
4. If necessary, configure your computer to work with an external USB mouse. See your computer documentation for details.

Connecting an External Monitor

If you want to monitor your presentation close-up (on a monitor placed beside the projector) as well as on the screen, you can connect an external monitor. You can use it to check on your presentation or switch between picture sources, even if you've pressed the **A/V Mute** button to turn off projection on the screen.

To attach an external monitor, connect it to the projector's **Monitor Out** port, as shown:

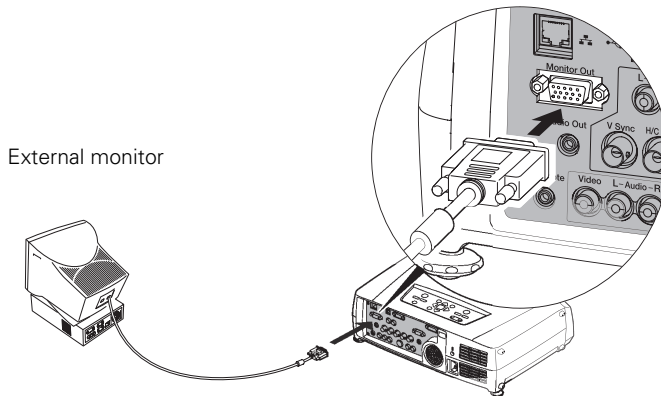

Follow these guidelines to view images on the monitor:

- The monitor displays the currently selected video source. Press the **Preview** button if you want to display all the active sources at the same time (see page 50).
- To be able to view (or preview) images on the monitor after pressing **A/V Mute**, first make sure the necessary setting is enabled. Enter the projector's Setting menu, then set the **A/V Mute** option to **Black** (if it's set to **Blue** or **Logo**, you won't be able to view images from a connected source after pressing **A/V Mute**).
- You can also view images on the monitor while the projector is in Standby mode, if this mode has been enabled (see page 73).

note

The monitor can display images from any connected computer or video source.

Playing Sound Through the Projector

You can play sound through the projector's speaker system, or you can attach an external speaker system. (Attaching speakers to the projector instead of directly to the audio source lets you use the projector's remote control to adjust the sound.)

Connecting Audio Equipment to the Projector

To play sound through the projector, follow these steps:

1. Locate the appropriate audio cable (two types are included with the projector). Which cable you use depends on how your equipment is connected:
 - If you have a computer connected to the **Computer** or **DVI** port, use the stereo mini-jack cable.
 - If you have video equipment connected to the **Video** or **S-Video** port, or to the **BNC** ports, use the RCA-style audio cable.
2. Connect the audio cable to the jack corresponding to the connected video source.

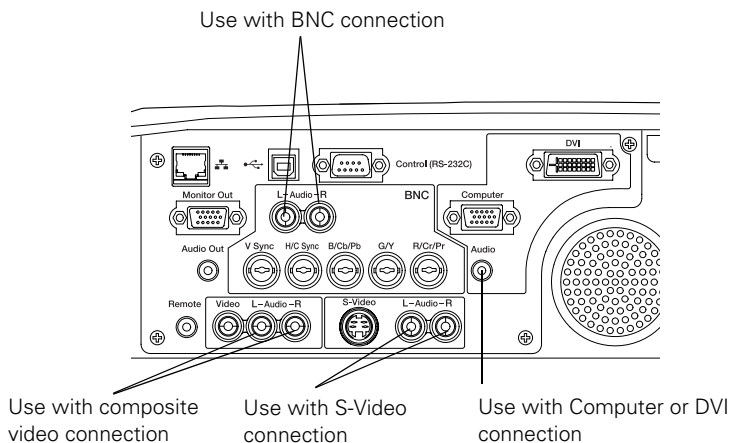

3. Connect the other end of the cable to the audio-output connector on your computer or video equipment.

Connecting External Speakers

To connect speakers to the projector, follow these steps:

1. Obtain the appropriate cable to connect your speakers.

Depending on your stereo system, you may be able to use a commercially available audio cable with a stereo mini-jack connector on one end, and pin jacks on the other end. For some speaker systems, you may have to purchase a special cable or use an adapter to connect to your speakers.

2. Connect the stereo mini-jack end of the audio cable to the **Audio Out** port on the projector.

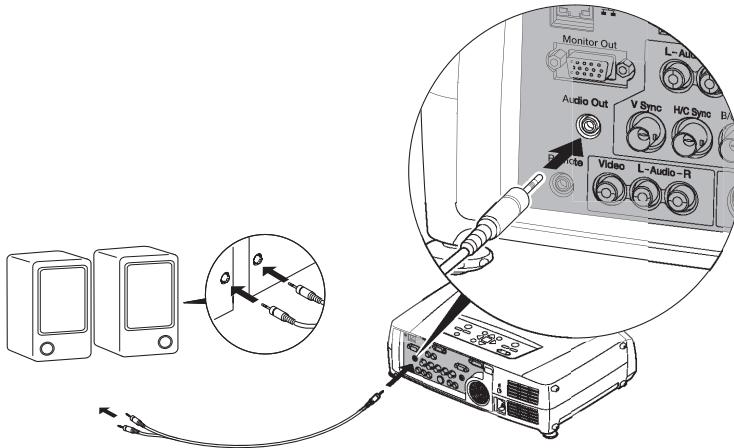

3. Connect the other end(s) of the cable to your speaker system. You may need to use an adapter to make the connection.

The projector's internal speaker system is disabled while sound is output to the external speakers.

2

Displaying and Adjusting the Image

Whether you're presenting from a computer or video equipment, you need to follow some basic steps to display your image on the screen.

Follow the guidelines in this chapter for:

- Turning the projector on and selecting the image source
- Troubleshooting display problems
- Adjusting the image
- Projecting images without a screen
- Protecting the projector with a password
- Turning off the projector

Projecting the Image

Make sure your projector and other equipment are set up as described in Chapter 1. Then follow the instructions below to start the projector and display an image.

note

To shut down the projector, see page 43. Shutting down the projector correctly prevents premature lamp failure and possible damage from overheating.

Turning on the Projector

If you turn on any connected computer or video equipment before starting the projector, this lets the projector automatically detect and display the image source. If you turn on the projector first, or have multiple pieces of connected equipment, you may have to select the image source manually (see page 30).

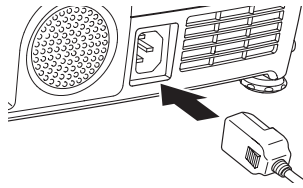

Follow these steps to turn on the projector:

1. Remove the lens cap.
2. Plug one end of the power cable into the projector, and the other end into a grounded electrical outlet.



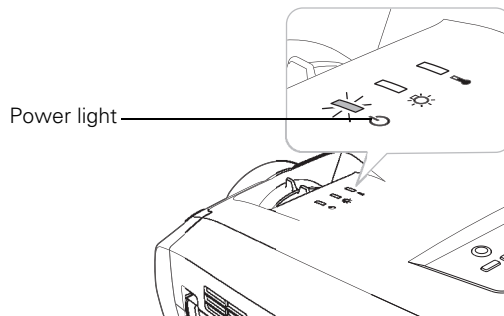

3. Wait until the  power light stops flashing and turns orange.

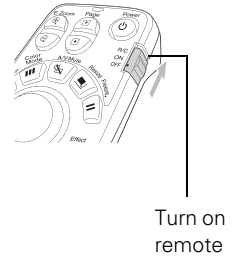
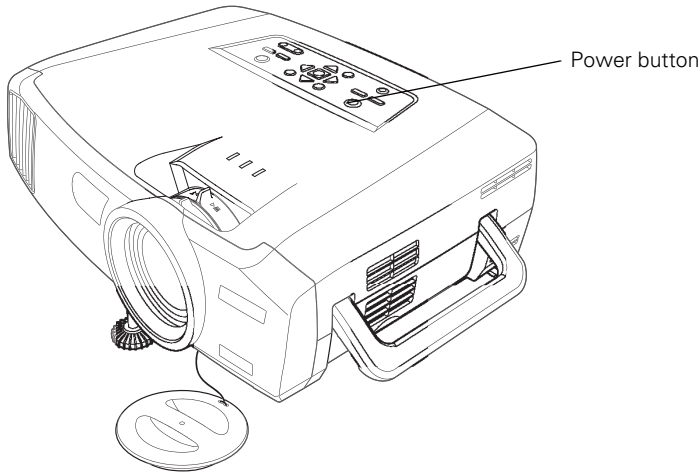

4. Press the red  Power button on top of the projector—or press the  Power button on the remote control.

(If this is your first time using the remote control, make sure the batteries are installed and the on/off switch on the side of the remote is turned on; see page 46.)



The  power light flashes green as the projector warms up, and an image begins to appear. When the  power light stops flashing and remains green (in about 40 seconds) the projector is ready for use.

5. If you've connected a Windows-based computer to the projector, you may see a New Hardware Wizard saying your computer has found a plug-and-play monitor; if so, click **Cancel**.

warning

Never look into the lens when the lamp is on. This can damage your eyes, and is especially dangerous for children.

note

To focus and adjust the image, see page 34. If a projected image fails to appear, see page 31 for help.

note

You can also preview all sources on one screen to help you select the desired source (see page 50).

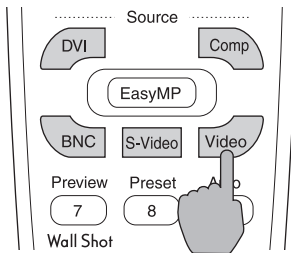

Selecting the Image Source

Selecting the image source lets you switch between images input from different pieces of equipment connected to the projector (such as a computer or DVD player).

If you don't see the image you want, select it using the **Source** buttons either on the projector or the remote control.

The **Source** buttons work as follows:

- The projector has two **Source** buttons. Use the **Computer/DVI** button to switch between equipment connected to the **Computer** and **DVI** ports.
Use the **Video/BNC** button to switch between equipment connected to the **Video**, **S-Video**, and **BNC** ports.
- The remote control has six **Source** buttons. Use them to switch between equipment connected to the port identified on each button. (The PowerLite 7800p does not support EasyMP.™)

Note that the **Computer** and **BNC** ports can be set up to use different input signals (for example, Analog RGB or RGB Video)—so if you have equipment connected to one of these ports, it's important to make sure the correct signal is selected to match the equipment you're using. You can change the input signal settings using the projector's menu system; see page 72.

Troubleshooting Display Problems

Follow these guidelines if you're having trouble displaying an image.

You Can't Project an Image

If you see a blank screen or a blue screen with the No Signal message, try the following:

- Make sure the cables are connected correctly, as described in Chapter 1.
- Make sure the power light is green and not flashing and the lens cap is off.
- If you've connected more than one computer and/or video source, you may need to press one of the **Source** buttons on the projector's control panel or the remote control to select the correct source. (Allow a few seconds for the projector to sync up after pressing the button.)
- If you're using a PC laptop, press the function key on your keyboard that lets you display on an external monitor. It may be labelled CRT/LCD or have an icon such as . You may have to hold down the Fn key while pressing it. Allow a few seconds for the projector to sync up after changing the setting.

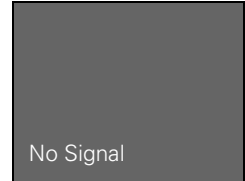

The Projector and Laptop Don't Display the Same Image

If you're projecting from a laptop, and you can't see your image on the screen and on your computer at the same time, follow these guidelines.

If you're using a PC laptop:

- On most systems, there's a function key that lets you toggle between the LCD screen and the projector, or display on both at the same time. It may be labelled CRT/LCD or with an icon such as . You may have to hold down the Fn key while pressing it. Allow a few seconds for the projector to sync up after changing the setting.

- If the function key doesn't permit you to display simultaneously on both screens, you should check your monitor settings to make sure both the LCD screen and the external monitor port are enabled.

From the Control Panel, open the **Display** utility. In the Display Properties dialog box, click the **Settings** tab, then click **Advanced**. The method for adjusting the settings varies by brand; you may need to click a **Monitor** tab, then make sure the external Monitor port is set as your primary display and/or enabled. See your computer's documentation or online help for details.

If you're using Macintosh OS X:

You may need to set up your system to display on the projector screen as well as the LCD screen. Follow these steps:

1. From the Apple menu, select **System Preferences**, then select **Displays**.
2. Make sure the **VGA Display** dialog box is selected.
3. Click the **Arrange** tab.

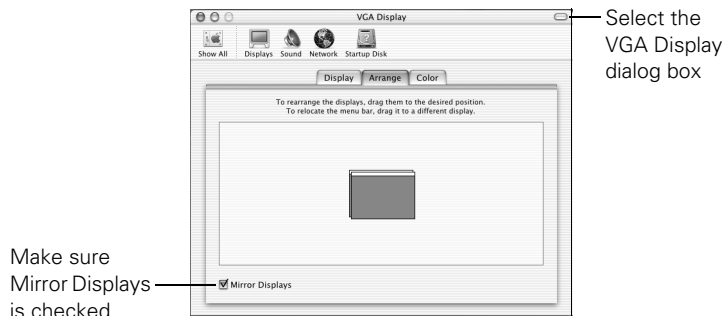

4. Make sure the **Mirror Displays** checkbox is selected.

If you're using OS 8.6 to OS 9.x:

You may need to set up your system to display on the projector screen as well as the LCD screen. Follow these steps:

1. From the Apple menu, select **Control Panels**, then click **Monitors** or **Monitors and Sound**.
2. Click the **Arrange** icon.

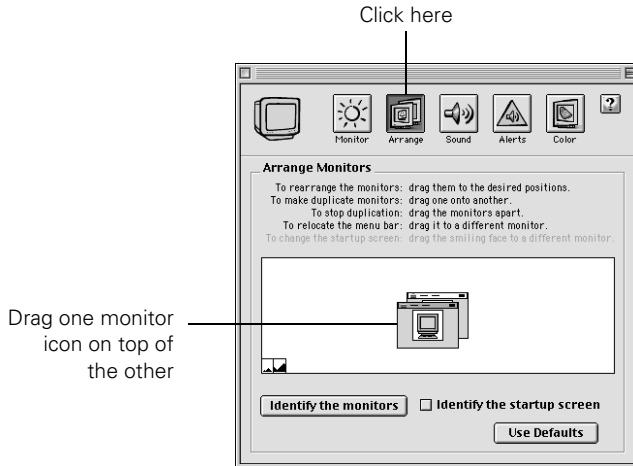

3. Drag one monitor icon on top of the other.

If the **Arrange** option isn't available, you may need to select one of the **Simulscan** resolution settings:

1. Click the **Monitor** icon.

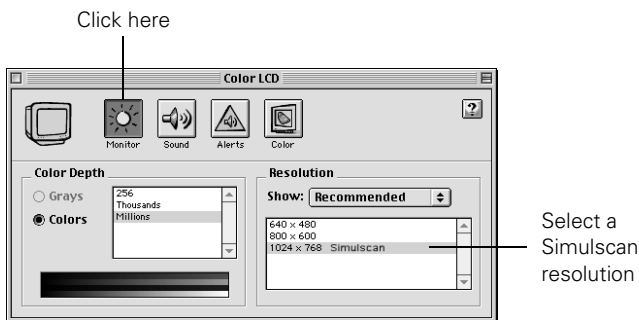

2. Select a **Simulscan** resolution as shown. (Allow a few seconds for the projector to sync up after making the selection.)

Adjusting the Image

Once you see your image, you need to make certain adjustments:

- To focus or zoom your image, see below.
- If the image is too high or too low, you can reposition it. See page 35.
- If the image isn't square, see page 36.
- If a computer image displays incorrectly, see page 39.

If you need to fine-tune the image and/or sound, see Chapter 4.

Focusing and Zooming Your Image

Use the **Focus** ring on the projector to sharpen the image.

Use the **Zoom** ring on the projector to reduce or enlarge the image. Move the tab toward the **W** to increase the size, and toward the **T** to decrease it.

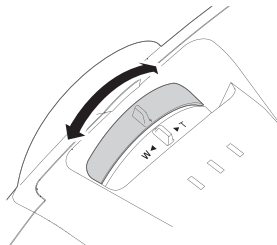

Focus ring

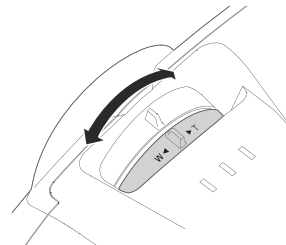

Zoom ring

If the image still isn't large enough, you may need to move the projector farther away from the screen. You can also use the **E-Zoom** buttons on the remote control to zoom in on a portion of the image. See page 51 for instructions.

Adjusting the Height of Your Image

If the image is too low on the screen, you can use the front adjustable foot to raise it.

1. Stand behind the projector. Press the blue foot release lever up and lift the front of the projector.

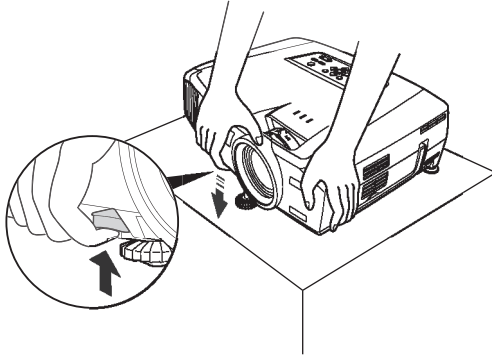

2. Once the image is positioned where you want it, release the lever to lock the foot in position.
3. If necessary, you can fine-tune the height by turning the projector's rear feet.

Raising the projector causes the image to distort or “keystone,” but you can manually correct the shape as described in the next section.

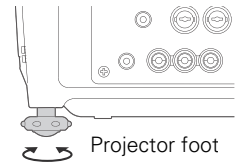

Adjusting the Image Shape

In most cases, you can maintain a square or rectangular image by placing the projector directly in front of the center of the screen with the base of the lens level with the bottom of the screen.

Even if the projector is slightly tilted (within a range of 40° up or down), the projector has an automatic keystone correction function that detects and corrects vertical keystone distortion.

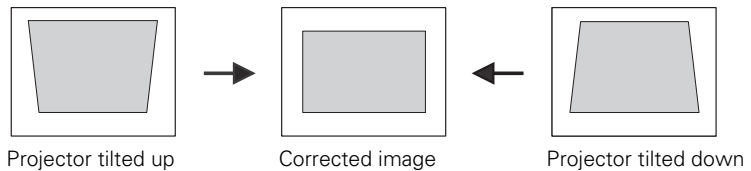

It takes about one second after projection starts for the image to be corrected. During this time, a vertical keystone correction gauge appears on the screen.

If your image is still distorted, you can correct it using either of these methods:

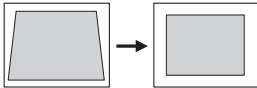

Keystone correction

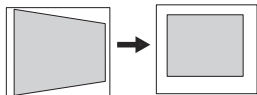

Keystone correction

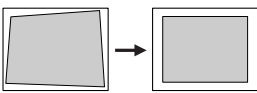

Quick Corner correction

- If the image has two parallel sides but is wider on one side (top, bottom, left, or right), you can correct it using the **Keystone** keys on the projector's control panel or the projector's Keystone menu (see "Using Keystone Correction" on page 37).
- If the image is trapezoid-shaped (no two sides are parallel), you can adjust its shape using Quick Corner™ (see page 37).

You cannot use both keystone correction and Quick Corner at the same time.

Using Keystone Correction

To adjust your image when it is wider on one side, do the following:

- Look at the shapes of the icons on the projector's four **Keystone** buttons. Press the button whose icon is the mirror image of the shape of your screen image. Continue pressing the button until you are satisfied with the shape of the image.

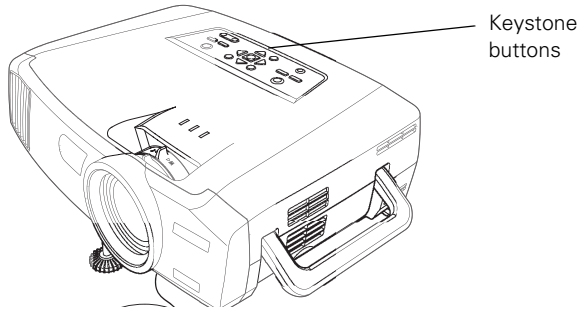

- Or press the **Menu** button on the remote control, select the **Setting** menu, and press **Enter**. From the **Setting** menu, select **H/V-Keystone** in the **Keystone** menu and press **Enter**. Select **V-Keystone** (for vertical keystone distortion) or **H-Keystone** (for horizontal keystone distortion) and press **Enter**. Use the  pointer button on the remote control to adjust the keystone setting as needed.

Using Quick Corner

Use Quick Corner to correct a trapezoid-shaped image, with no parallel sides:

1. Press the **Menu** button on the remote control (or on the projector's control panel).
2. Select the **Setting** menu and press **Enter**.
3. From the **Setting** menu, select **Keystone** and press **Enter**.
4. Select **Quick Corner** and press **Enter**.

note

*The image will be slightly shorter after adjusting. If it's important to maintain the correct aspect ratio, use the menu system to perform keystone correction, then adjust the **Height** setting as needed. See page 69.*

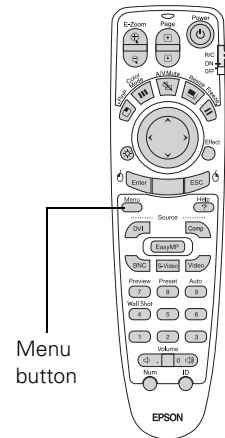

note

For more information on using the menu system, see Chapter 4.

You see this screen:

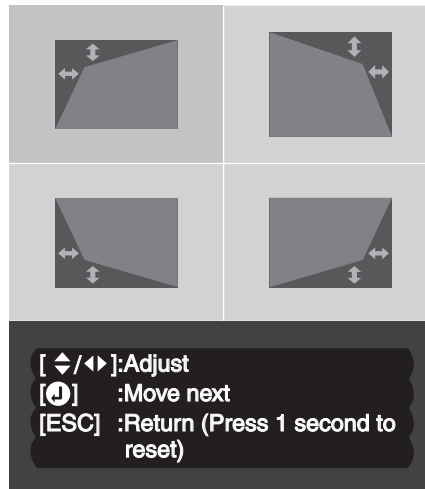

note

If you are not satisfied with the corrections made, press the ESC button for one second to reset the screen to its original shape.

5. Press the Enter button to select the corner you want to adjust.
6. Use the  pointer button on the remote control (or the arrow buttons on the projector) to adjust the shape.
7. Repeat steps 5 and 6 as needed to adjust any remaining corners.
8. When done, press the ESC button on the remote control or projector's control panel to exit the menu system.

If Quick Corner remains selected in the Keystone menu, the Quick Corner screen appears whenever you press the projector's Keystone buttons. You can then follow steps 5 through 8 above to correct the shape of your image, or press ESC to exit Quick Corner.

Correcting Computer Images

If you're connected to a computer and the image doesn't look right, press the **Auto** button on the remote control (or the **↵ Auto/Enter** button on the projector's control panel). This automatically resets the projector's tracking, sync, resolution, and position settings.

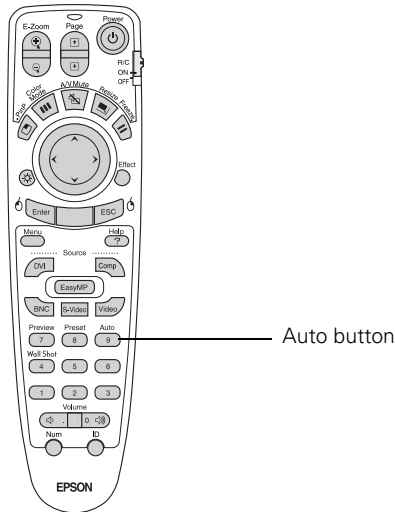

note

You must be projecting an image for this button to have any effect. The Auto button works only with computer images.

If vertical stripes appear in the projected image and the **Auto** button doesn't correct the problem, hold down the **Shift** button on the projector's control panel while pressing either the **Tracking +** or the **Tracking -** button.

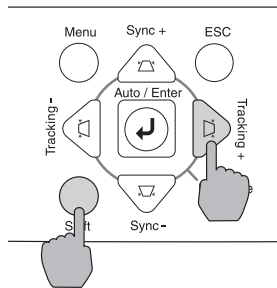
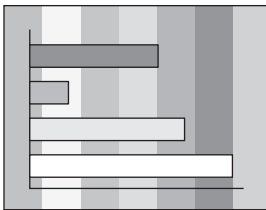

If the image appears fuzzy or flickers and the **Auto** button doesn't correct the problem, hold down the **Shift** button while pressing either the **Sync +** or **Sync -** button.

Projecting Images Without a Screen

Even if you don't have a screen, you can project images onto surfaces like blackboards and colored walls without loss of image color. Your projector has a sensor that measures the conditions of the projection surface and automatically adjusts the colors and shading of your image. For example, if you're projecting onto a surface near a window, your image appears clear and well-defined rather than faint.

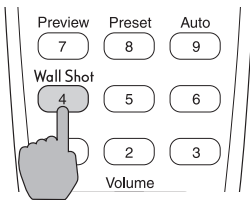

Making Initial Color Corrections

Press the **Wall Shot** button on either the remote control or the projector's control panel while projecting an image.

Wall Shot's status appears in the upper right corner of your screen. Then you see a sequence of colors flash for approximately five seconds while the sensor measures the conditions of the projection surface and adjusts the image.

note

*If the status message indicates that Wall Shot is off, press the **Wall Shot** button again to turn it on.*

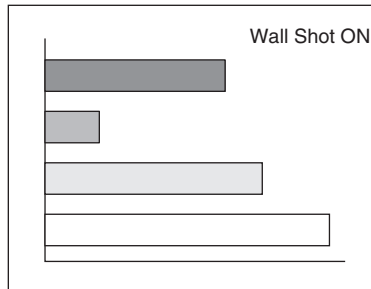

When you turn the projector off, the projector stores the correction values obtained by the last Wall Shot measurements. This is useful if you're projecting against the same surface and under the same conditions. To retrieve these corrections, just press the **Wall Shot** button again while projecting an image.

Adjusting Color Corrections for a New Surface

Adjust the correction values if you're projecting on a new surface or in a new location.

1. Press the **Wall Shot** button on the remote control or projector while you're projecting an image. Wait for the Wall Shot status screen.
2. Press the **Wall Shot** button until you see **Wall Shot Readjustment** on the status screen.

You see a sequence of colors flash for about five seconds as the projector adjusts the color correction values for the new projection surface.

Enabling Password Protection

To prevent unauthorized use, you can assign the projector a password. If you do, a screen will appear requesting the password whenever the projector is plugged in. If an incorrect password is entered three times in succession, the projector's operation is locked and the power cord must be disconnected and reinserted to redisplay the password screen. If an incorrect password is entered nine times in succession, the user must contact the dealer to unlock the projector.

The default setting for the Password Protect function is off. Follow these steps to turn password protection on:

1. Press the **Freeze** button on the remote control for about five seconds.

You see this screen:

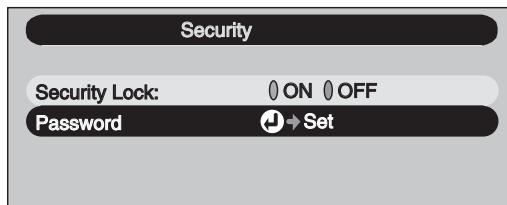

note

It's a good idea to write your password down. Also, make a note of the "Request Code: xxxxxx" number that appears in the Password Protect Release screen. If you do forget the password, you'll need this code when you contact the dealer.

If you leave the projector plugged in, the Password Protect Release screen will not appear. You only need a password if you unplug and reconnect the power cable.

caution

If you lose the remote control, you will not be able to enter the password. Keep the remote control in a safe place at all times.

2. Use the  pointer button to set **Security Lock** to **ON**. Then press the **Enter** button.
3. Select **Password** and press the **Enter** button.
4. When you see a message asking if you want to change the password, select **Yes** and press **Enter**.
5. Press the **Num** button on the remote control. When it lights, the numeric keypad is activated.
6. Use the numeric keypad to enter a four digit password. (The default setting is 0000.)
7. When you see a confirmation message, reenter the password. Then press the **Menu** button to exit the screen.
8. Press the **Num** button on the remote control to deactivate the numeric keypad.

Starting the Projector with a Password

When Password Protect is enabled, you see this screen when you plug in the projector:

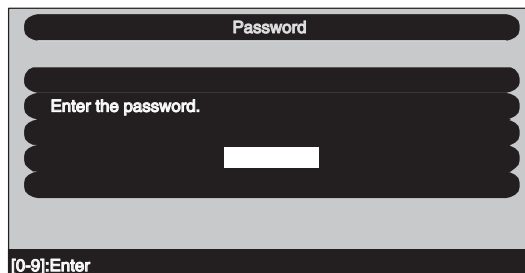

1. Press the **Num** button on the remote control to activate the numeric keypad.
2. Enter the four digit password.
3. Press the **Num** button to deactivate the numeric keypad.

The Security Lock Release screen closes, and projection begins.

Shutting Down the Projector

When you've finished using the projector, follow the recommended procedure to shut it down. This extends the life of the lamp and protects the projector from possible overheating.

1. Turn off and disconnect any equipment plugged into the projector.
2. To turn off the projector, press the red  **Power** button on the projector or remote control.

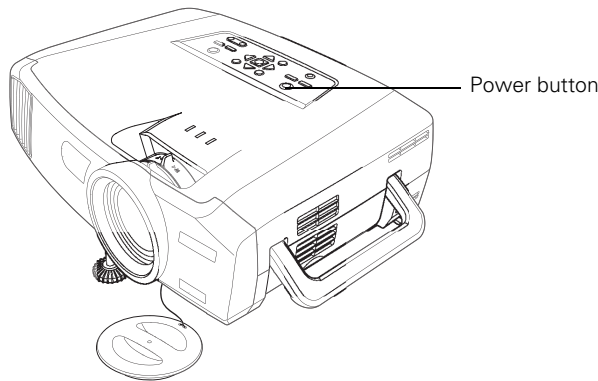

You see a confirmation message. (If you don't want to turn it off, press any other button.)

3. Press the **Power** button again. The power light flashes orange for about 30 seconds as the projector cools down. After the projector has cooled, the orange light stays on and the exhaust fan shuts off.
If you want to turn the projector on again, wait until the orange light stops flashing. Then press the **Power** button.
4. If you extended the adjustable front foot, press up on the blue foot release lever to retract it.
5. Replace the lens cap and unplug the power cord.
6. If you're using a remote control, set its on/off switch to **OFF**. This conserves battery power.

note

*When the projector has not received any input signals for 30 minutes, it automatically turns off the projector lamp and enters "sleep mode." This conserves electricity, cools the projector, and extends the life of the lamp. If you want to start projecting again, press the **Power** button. If you are done using the projector, unplug the power cord. To turn off sleep mode, see page 74.*

Power OFF?

Yes : Press  button
No : Press any other button

caution

To avoid damaging the projector or lamp, never unplug the power cord when the power light is green or flashing orange.

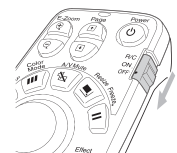

3

Giving Your Presentation

The projector includes a number of tools to enhance your presentation. All of them can be accessed using the remote control, which lets you operate the projector from anywhere in the room—up to 33 feet away.

note

For information and resources to help you give the most professional presentation, be sure to visit presentersonline.com.

You can use the remote control to adjust the picture and sound (page 49), or as a pointer or drawing tool to highlight your presentation (page 54). You can also use it as a wireless mouse when projecting from a computer (page 56); this lets you easily change slides, for example, when giving presentations in PowerPoint.

To further enhance your presentation, you can create a customized screen to display a picture or company logo (page 57), and then use it as the startup screen or the screen you see when you press the A/V Mute button.

This chapter covers:

- Activating and using the remote control
- Controlling the picture and sound
- Highlighting your presentation
- Operating your computer with the remote control
- Creating your own startup screen
- Controlling multiple projectors

Activating and Using the Remote Control

The remote control has an on/off switch on its side, as shown. Before using the remote, make sure batteries are installed as described on page 48, then push up on the on/off switch to turn it on.

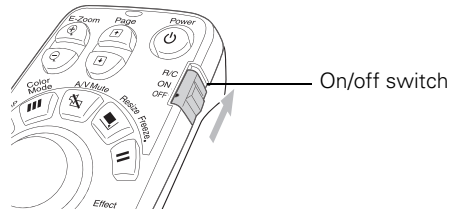

note

If a button is pressed longer than 60 seconds, the remote control stops operating to conserve power. When you release the button, normal operation resumes.

Turn off the remote control before transporting or storing it; this prevents the batteries from discharging if something presses against one of the buttons.

Here are some additional tips:

- Point the remote control either at the front or back of the projector, or at the screen.
- Stand within about 30 feet of the projector. If you want to operate the projector from a greater distance, a remote control cable set is available (see page 6).
- When presenting in a darkened room, press the ☼ light button to make the buttons on the remote light up temporarily.
- Avoid using the remote under bright fluorescent lamps or in direct sunlight, or the projector may not respond properly.

Using the Navigation Buttons

The remote control has various buttons that let you navigate the projector's help and menu systems; they also let you use the drawing tools to highlight your presentation. If you've connected a computer, the buttons can be used in place of your computer's mouse, letting you walk about freely while controlling your presentation.

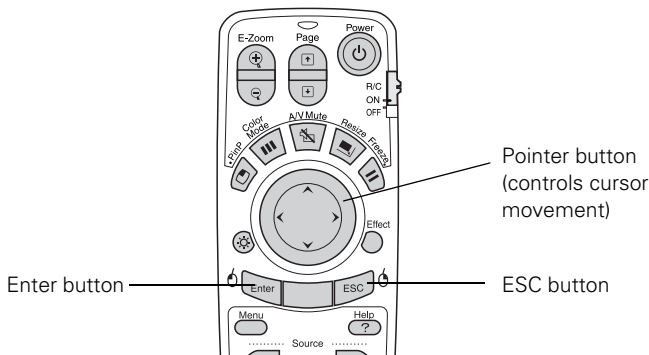

For details on using the buttons to control specific features, see the following sections:

- to navigate the projector's menu system, see page 64
- to use the projector's help system, see page 102
- to highlight your presentation, see page 54
- to use the remote control in place of your computer's mouse, see page 56
- to create your own startup screen, see page 57
- to use the remote to control more than one projector, see page 60

note

The projector has equivalent buttons that you can use on its control panel:

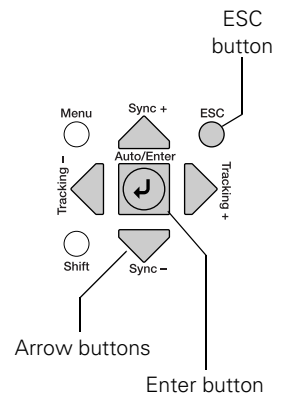

Replacing the Batteries

If the projector stops responding to the remote control, check the following:

- Make sure the remote control's on/off switch (shown on page 46) is in the ON position.
- Press the ☼ light button and check to see if the buttons on the remote control light up. (If you're in a bright room, you may not be able to see them light.)

If the buttons do not light up, replace the batteries as described below:

1. Turn the remote control over.
2. Press down on the ridges at one end of the battery cover as you slide the cover off.
3. Install two AA batteries, inserting the flat (negative) ends in first.
4. Slide the cover back in place.

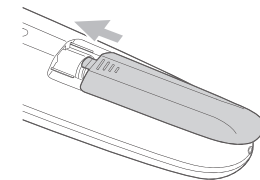
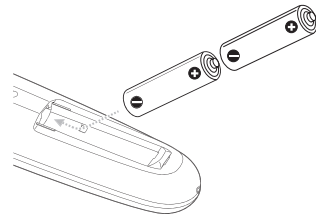
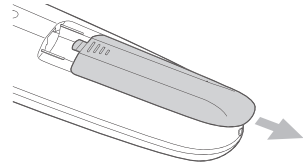

caution

When replacing batteries, take the following precautions:

- *Replace the batteries as soon as they run out. If the batteries leak, wipe away battery fluid with a soft cloth. If fluid gets on your hands, wash immediately.*
- *Do not expose batteries to heat or flame.*
- *Dispose of used batteries according to local regulations.*
- *Remove the batteries if you won't be using the projector for a long period of time.*

Controlling the Picture and Sound

You can use the remote control to preview and select your picture sources, temporarily turn off the picture and sound, freeze the action, zoom in on the picture, display a picture-in-picture image, and adjust the volume.

Switching Between Picture Sources

If your projector is connected to more than one computer and/or video source, you can switch between the different sources:

- On the projector's control panel, there are two **Source** buttons: Press the **Computer/DVI** button to switch between equipment connected to the **Computer** and **DVI** ports. Or press the **Video/BNC** button to switch between equipment connected to the **Video**, **S-Video**, and **BNC** ports.
- On the remote control, there are six **Source** buttons. Use them to switch between equipment connected to the port identified on each button. (The **EasyMP** button is not functional with the **PowerLite 7800p**.)

Note that the **Computer** and **BNC** ports can be set up to use different input signals (for example, **Analog RGB** or **RGB Video**)—so if you have equipment connected to one of these ports, it's important to make sure the correct signal is selected to match the equipment you're using. You can change the input signal settings using the projector's menu system; see page 72.

After you select a source, the screen goes dark for a moment before the image appears.

note

You can use the projector's menus to fine-tune the picture and sound quality as described in Chapter 4.

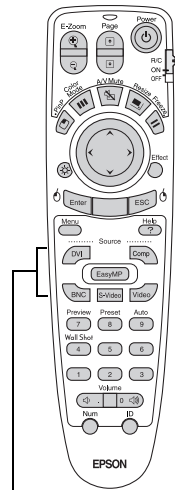

Source buttons

Previewing Picture Sources

You can use the Preview function to help you select the image source.

1. Press **Preview** on the remote control.

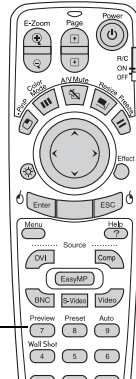

Preview button

note

Movies are displayed as still images on the preview screen.

You see the currently selected source displayed in the main window, as shown. All other sources (including the currently selected source) are displayed in smaller preview windows on the right side and at the bottom. If no equipment is connected to a port, or if there is no incoming signal, the preview window for that source appears blank.

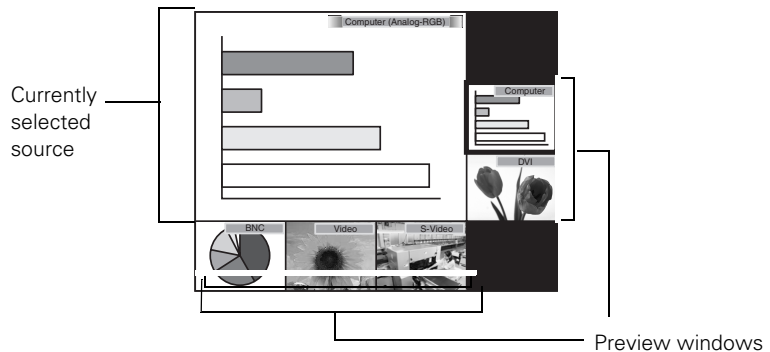

note

*A red highlight surrounds the preview window for the currently selected source. You can use the  pointer button on the remote control to highlight a different source, and then press **Enter** to display it.*

2. Press one of the **Source** buttons on the remote control to switch to the desired source, and press **Enter** to change the source and exit the screen. Or press **ESC** to exit the preview screen without switching sources.

Turning Off the Picture and Sound

You can use the **A/V Mute** button on the remote control to turn off the image and sound and darken your screen. (If you've connected an external monitor to the projector, it will continue displaying.) This feature is useful if you want to temporarily redirect your audience's attention without the distraction of a bright screen.

- To turn off the picture, press the **A/V Mute** button. The screen goes dark.
- To turn the image back on, press the button again.

You can also have an image, such as a company logo, display on the screen whenever you press the **A/V Mute** button (see page 57).

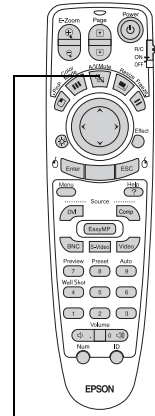

A/V Mute button

Stopping Action

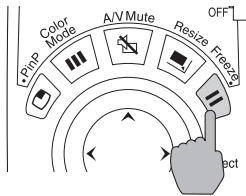

You can use the remote control to stop the action in your video or computer image.



- Press the **Freeze** button to stop the action and keep the current image on the screen. The sound continues.
- Press the **Freeze** button again to restart it.

Zooming Your Image

You can zoom in on a portion of the image using the **E-Zoom** buttons on the remote control.

1. Press the **E-Zoom**  button on the remote control.
You see a crosshair indicating the center of the zoom-in area.
2. Use the  pointer button to position the crosshair.

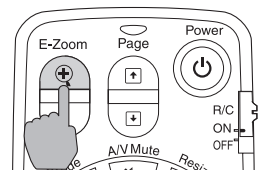

note

This function pauses the image, but not the sound. Also, because the source continues to transmit signals, you won't resume the action from the point you paused it.

3. Continue pressing the E-Zoom \oplus button to enlarge the selected area up to 4 \times .
4. While the image is enlarged, you can:
 - Use the \odot pointer button to pan about.
 - Press the E-Zoom \ominus button to zoom out.
5. When done, press the ESC button to return to the original size.

Displaying a Picture-in-Picture Video

If you're displaying an image from equipment connected to the DVI, Computer, or BNC port(s), you can open up a smaller picture-in-picture window on the screen. This window can display video from equipment connected to either the Video or S-Video port.

Setting Up the P-in-P Image

Before starting, make sure the computer or video equipment for your main image is connected to the DVI, Computer, or BNC port(s), and the video equipment for the P-in-P window is connected to the Video or S-Video port. Then select the corresponding video setting:

1. Press the Menu button on the remote control, and enter the Setting menu.
2. Highlight P in P, use the pointer button to select either Composite or S-Video, then press Enter.
3. Press ESC to exit the menu system.

Displaying the P-in-P Image

Make sure your main image source is displayed, then follow these steps to display and use the Picture-in-Picture window:

1. Press the P in P button on the remote control.
2. Use the \odot pointer button to reposition the video window; use the E-Zoom buttons to reduce or enlarge it.

note

The Picture-in-Picture function does not work for RGB video images.

note

Select Composite if your P-in-P video equipment is connected to the Video port.

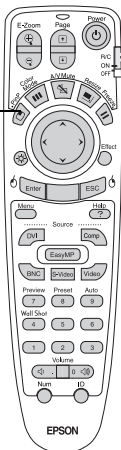

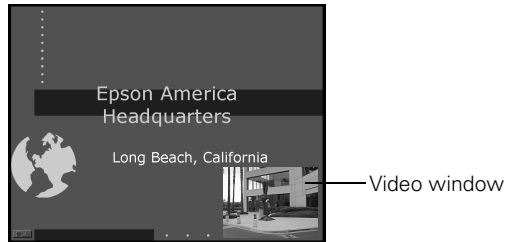

P in P button

- Once the window is located and sized the way you want it, press the **Enter** button; your video continues playing on the screen.



- When you're finished viewing the Picture-in-Picture, press the **P in P** or  pointer button again. The window disappears.

Controlling the Volume

To change the volume, press the  or  side of the **Volume** button.

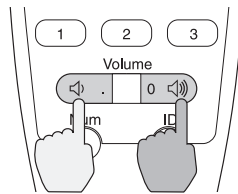

If necessary, you can adjust the tone using the projector's menu system. See page 71.

note

*To temporarily shut off the sound (and picture), press the **A/V Mute** button.*

Highlighting Your Presentation



You can display a pointer to call out something on the screen, or draw straight or curved lines to emphasize particular points. There are three preset pointer tools you can choose from, and each one can be customized for a different look.

Using the Pointer Tool

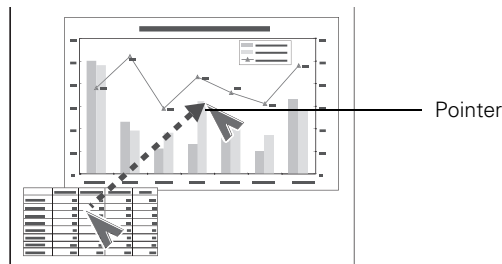
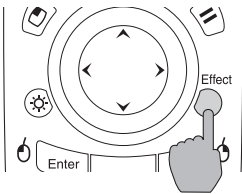
1. To activate the pointer tool, press the **Effect** button on the remote control. A pointer appears on the screen.



If you prefer to use a different style of pointer, continue pressing the **Effect** button to select the desired style. Three preset options are available, but you can customize the look of each one (see page 55).

2. Use the  pointer button on the remote control to position the pointer on the screen.
3. To draw a straight line, place the pointer where you want the line to begin and press **Enter**. Move the pointer to where you want the line to end, and press **Enter** again.
4. To draw a curved line, place the pointer at the start of the line, then press and hold the **Enter** button until it lights. Then use the  pointer button to move the pointer and draw on the screen. Press **ESC** when done.
5. If you want to draw additional lines, repeat steps 3 and 4.
6. When done drawing, press **ESC** to clear the screen.

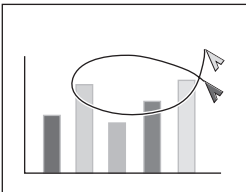



Customizing the Pointer Tools

You can customize the shape and size of each of the three pointer tools, select the color and width of the line made with each pointer, and set how fast you can move the pointer across the screen.

1. Press the **Menu** button on the remote control, highlight the **Effect** menu, and press **Enter**.

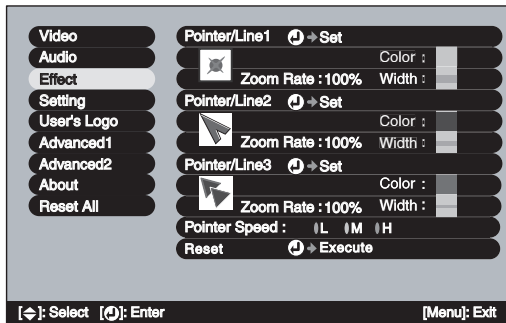
You see this screen:





2. For each of the three Pointer/Line icons, you can change the following settings:
 - **Shape**
Lets you select one of the following pointer shapes:

 - **Zoom Rate**
Changes the size of the pointer
 - **Color**
Changes the color of the line you can draw using the pointer
 - **Width**
Changes the line width
3. You can also change the **Pointer Speed** setting to adjust how fast the pointer tool moves across the screen.
4. When done, press **ESC** until you exit from the menu system.

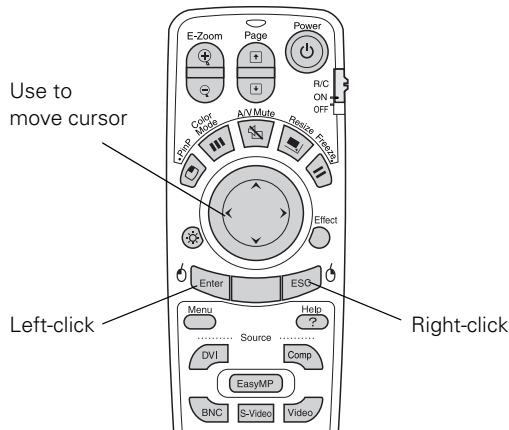
Operating Your Computer with the Remote Control

If you've connected a computer to the projector with a USB cable, as described on page 22, you can use the remote control in place of your computer's mouse. This gives you more flexibility when delivering PowerPoint and other slideshow-style presentations, since you won't have to stand next to the computer to change slides.

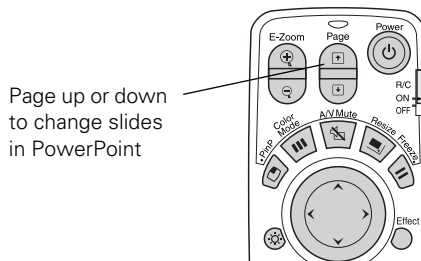

- Use the  pointer button to move the cursor on the screen.
- Press the **Enter** button to left-click, or press it twice to double-click; press the **ESC** button to right-click.
- To drag-and drop, hold down the **Enter** button for about one second until it lights. Then use the  pointer button to drag the object. When it's where you want it, press **Enter** to release it.
- Use the **Page** buttons to move through a slideshow.



Creating Your Own Startup Screen

You can transfer any image from your computer or video source to the projector, and then use it as your startup screen. You can also use it as the screen to be displayed when the projector is not receiving a signal or when you press the **A/V Mute** button. The image can be a company logo, slogan, photograph, or any other image you want to use.

Capturing the Image

Start by displaying the image you want to use. It can be an image from either a computer or video source such as a DVD player or digital camera. Then follow these steps to capture the image and transfer it to the projector:

1. Press the **Menu** button on the remote control, highlight the **User's Logo** menu, and press **Enter**.

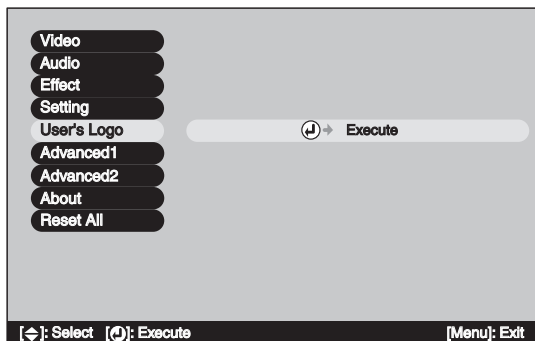

2. When you see a message asking whether you accept the present image as the user's logo, select **Yes** and press **Enter**.
3. A selection box displays over the image. Use the  pointer button to select the area of the image you want to use. Then press **Enter**.

4. When you see the message **Select this Image?**, highlight **Yes** and press **Enter**.
5. Use the arrow buttons to select a zoom rate (display size), and then press **Enter**.

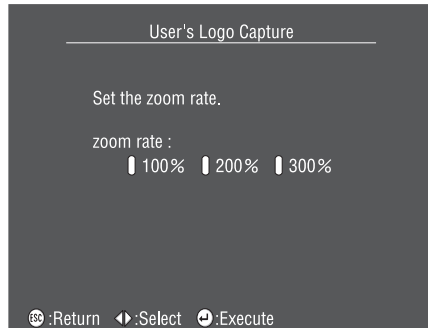

6. When the message **Save image as user's logo?** appears, select **Yes** and press **Enter**.
Saving the logo may take a few moments. Do not use your projector or video source (computer, DVD player, etc.) while the logo is being saved.
7. When you see the message **Completed**, press **ESC** to return to the menu screen.

Choosing When to Display the Image

After your image is saved, you can set it up as the startup screen, or the screen you see when there's no signal or when you press the **A/V Mute** button (see page 51).

1. Press the **Menu** button to display the menu screen (if not already displayed).
2. To display your image as the startup screen, highlight the **Advanced1** menu, then press **Enter**. Select **Startup Screen**, highlight **ON**, then press **Enter**.

To display your image on the No-Signal or A/V Mute screen, continue with the following steps.

3. Highlight the **Setting** menu, then press **Enter**.
4. Select the screen(s) on which you want your image to appear:
 - Highlight **No-Signal Msg.** if you want to display your image (instead of a blank screen) when there is no video signal incoming from the currently selected source.
 - Highlight **A/V Mute** if you want your image to appear when you press the **A/V Mute** button.
5. Select **Logo**, then press **Enter**. This sets your image as the screen to be displayed. (Or select **Blue** if you prefer to display a blue screen instead.)
6. When you're finished, press **ESC** to exit.

Controlling Multiple Projectors

If you're using more than one projector, you can control all the projectors—or just selected ones—by using the projector ID system. To operate a projector, you have to set the remote control's ID to match that of the projector. Or you can control all of the projectors simultaneously by setting the remote control's ID to zero.

Setting the Projector ID

The projector's default ID is 1. If you need to change it, follow these steps:

1. Press the **Menu** button on the remote control.
You see the projector's menu screen.
2. Select the **Advanced2** menu and press **Enter**. Then highlight **Projector ID** and press **Enter**.

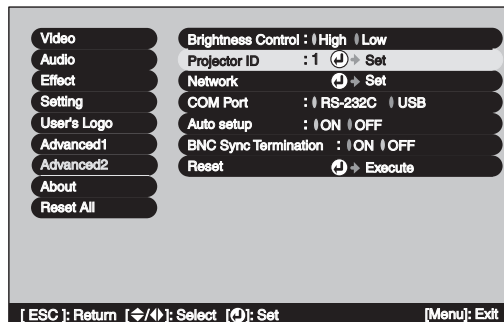

3. Press the right or left side of the  pointer button to increase or decrease the ID value.
4. Press **Enter** to set the value.
5. When done, press **ESC** to exit the menu system.

Setting the Remote Control ID

The remote control's default ID is zero. If you need to change it, follow these steps:

1. Press the ID button on the remote control. You see it light.
2. Press one of the numbered buttons on the remote control to select the desired ID (0 through 9). Select zero to control all projectors, or select a number to match the ID of the projector(s) you want to operate.

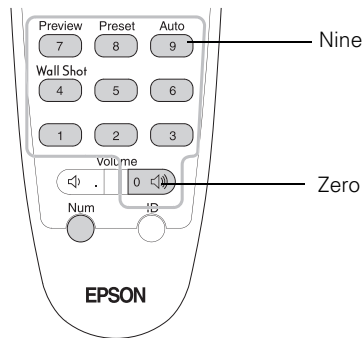
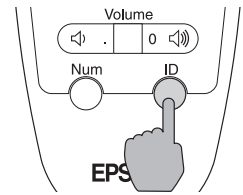

The ID button's light shuts off and the new ID is registered.

If you would like to check the remote control's current ID, do the following:

1. Press the ID button twice in succession. After a moment, the button flashes.
2. Count the number of flashes; this number corresponds to the remote control's ID. (If it doesn't flash, the ID is set to zero.)

4

Fine-tuning the Projector

You can use the projector's on-screen menus to adjust the image, sound, and other features. This chapter covers the following information:

- Using the menu system
- Adjusting the image quality
- Adjusting the image size, shape, and position
- Adjusting the color
- Adjusting the sound
- Customizing projector features

Using the Menu System

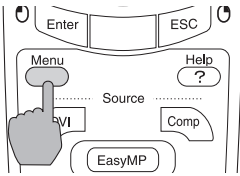

You can use the remote control (or the projector's control panel) to access the menus and change settings. Follow these steps:

1. To display the menu screen, press the **Menu** button.

You see a menu screen similar to the one shown below (the settings may differ from those shown here, depending on the selected input source):

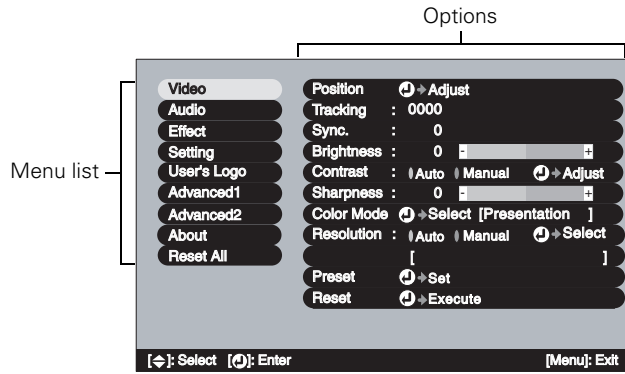



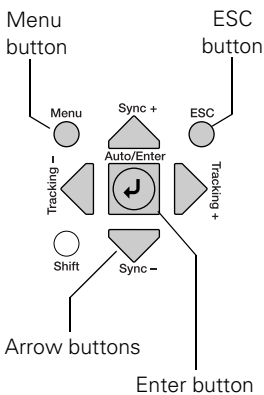

note

You can also use the buttons on the projector to access the menu system:



The menus are listed on the left, and the options available for the highlighted menu are shown on the right.

2. Use the  pointer button on the remote control (or the arrow buttons on the projector) to scroll through the menu list. When you've highlighted the desired menu, press the **Enter** button to select it.
3. Once you've selected the menu, use the  pointer button to scroll through the list of options. (Some of the options may be grayed out or unavailable, depending on the selected source.)

4. After highlighting the option you want to adjust, use the  pointer button to change the setting. In some cases, you may have to press the Enter button to see a sub-screen for changing the setting.
 - Press the left or right side of the  pointer button to adjust a slider bar.
 - To select from two or more settings, use the  pointer button to highlight the desired setting, then press Enter.
5. After changing the settings, press the ESC button to save your changes and return to the previous menu (or press it repeatedly to exit the menu system).



You can also press the Menu button to exit.

Restoring the Default Settings

You can use the menu system's Reset options to restore the factory-default settings for:

- all the settings listed in a specific menu
- all the settings in all menus

To restore the settings in a specific menu, enter the menu whose settings you want to change, select Reset, and confirm as needed. (The example below shows how to reset the Video menu.)

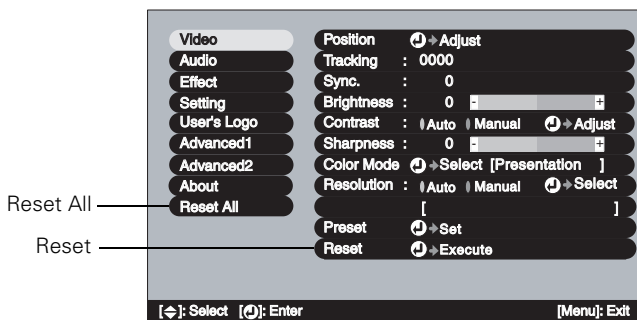

note

Reset All *does not* reset the Computer Input, BNC Input, User's Logo, Language, Projector ID, Network, and Lamp settings.

To restore all the projector settings to their factory-default values, select Reset All.

Adjusting the Image Quality

You can use the Video menu to adjust the brightness, sharpness, color, tint, and contrast. If you're projecting from a computer (but not through the DVI port), there are additional adjustments you can make (see page 67).

Adjusting Images from Video Sources

1. Press the Menu button on the remote control, then select the Video menu.

You see the Video menu screen. (The actual settings may vary, depending on the selected input source. The Video menu below is for a composite video or S-Video source.)

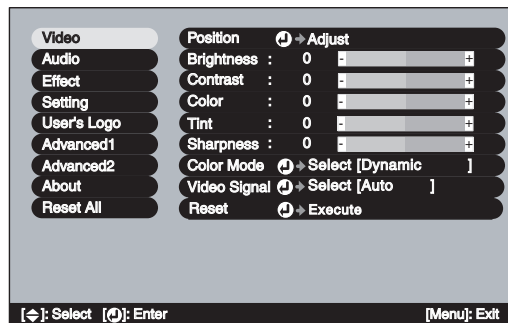

note

The Brightness setting changes the opacity of the projector's LCD panels. You can also adjust the brightness of the lamp itself. Select Brightness Control in the Advanced2 menu, then choose High or Low (the default setting is High). Selecting the low brightness setting extends the life of the lamp (see page 118).

2. Use the  pointer button to highlight the desired option, then adjust it as needed:
 - **Position**
If the image is slightly cut off on one or more sides, it may not be centered exactly. Use this setting to center it (not available for RGB video images).
 - **Brightness**
Lightens or darkens the overall image.
 - **Contrast**
Adjusts the difference between light and dark areas.

- **Color**
Adjusts the color intensity, from black-and-white to full color (not available for RGB video images).
- **Tint**
Adjusts the tint of the image (not available for RGB video images).
- **Sharpness**
Adjusts the sharpness of the image.

Adjusting Computer Images

You can also adjust brightness, contrast, and sharpness when you're projecting a computer image. In addition, if you're projecting an analog RGB image transmitted through the Computer or BNC port(s), you can make several other settings.

1. Press the **Menu** button on the remote control, then select the **Video** menu.

You see a screen similar to the one below. (The settings will be different if you're projecting a digital RGB image transmitted through the DVI port.)

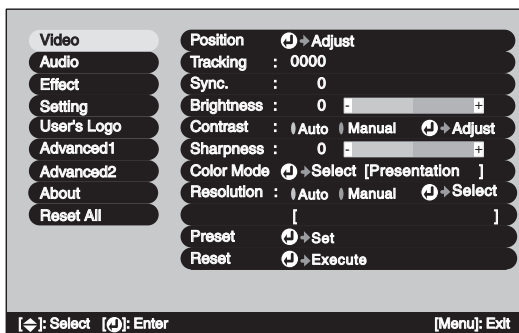

- **Position**
If the image is slightly cut off on one or more sides, it may not be centered exactly. Use this setting to center it.
- **Tracking**
Adjust this value to eliminate vertical stripes in the image.

note

You can also use the remote control's **Auto** button to automatically reset the projector's tracking, sync, resolution, and position settings. See page 39 for details.

tip

Before adjusting tracking or sync, fill the screen with an image containing fine detail. For example, in Windows you can select a pattern to appear as your desktop background. If this option isn't available, try projecting black text on a white background.

- **Sync**
Adjust this value if the image appears blurry or flickers.
- **Brightness**
Lightens or darkens the overall image.
- **Contrast**
Adjusts the difference between light and dark areas. Select **Auto** to let the projector adjust the contrast automatically, or select **Manual** to adjust the setting yourself. (Press **Enter** after you make the selection.)
- **Sharpness**
Adjusts the sharpness of the image.
- **Resolution**
If your image is distorted (compressed, stretched, partially cut off, or doesn't completely fill the display area), the projector's resolution setting may not match that of your computer. Select **Auto** to let the projector adjust the resolution automatically, or **Manual** to adjust the setting yourself. (Press **Enter** after you make the selection.)
- **Preset**
Once you've fine-tuned the settings in the Video menu for the computer you're using, you can save them as a group using one of the ten **Preset** settings. The next time you use the same computer, simply press the **Preset** button on the remote control to recall your saved settings. (Press the **Preset** button repeatedly to select the number corresponding to the setting you want to use.)

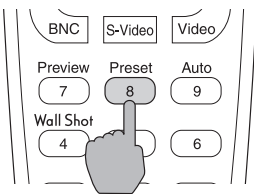

Adjusting the Image Size, Shape, and Position

Whether you're projecting from a computer or video player, you can use these settings to adjust the size, shape, and position of the image.

■ Resize button

Adjusts how an image fits into the display area.

For computer images, resizing is normally unnecessary, since the projector automatically resizes the image to make the best use of the display area. If you press the **Resize** button on the remote control, the projector displays the image at the output resolution of the computer (which makes the image larger or smaller, depending on its resolution). If the resolution of the image is the same as the projector's (1024 × 768), pressing **Resize** has no effect.

For video images, pressing **resize** switches the aspect ratio between 4:3 and 16:9. This lets you play certain digital video images or movies recorded on certain DVDs in 16:9 widescreen format.

■ Keystone (in the Setting menu)

Squares up the shape of the image after the projector has been tilted upward or angled to one side (see page 36). If you notice lines or edges looking jagged after adjusting the shape, decrease the Sharpness setting (see page 68).

■ Position (in the Video menu)

If the image is slightly cut off on one or more sides, it may not be centered exactly. You can use this setting to center it (not available for digital RGB or RGB video images).

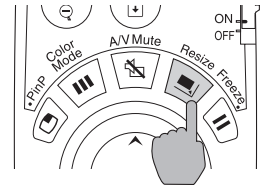

note

If your computer image is stretched, compressed, or doesn't fit correctly on the screen, you should try adjusting the Resolution setting first (see page 68).

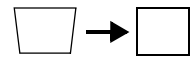

Adjusting the Color

The projector provides several ways for you to adjust the color:

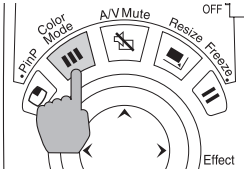

- **Color Mode button (also in the Video menu)**
Lets you quickly adjust the color and brightness for various environments. Use either the remote control or the **Color Mode** setting in the Video menu; you can save a different setting for each computer and/or video source. Select from these settings:

sRGB: To use the sRGB standard for computer displays (the default when projecting from a computer with analog video)

Dynamic: For presentations in bright rooms

Presentation: For presentations in dark rooms

Theatre: For optimizing movie images with natural color (the default for video display)

Living Room: For optimizing video games

- **Color (in the Video menu)**
Adjusts the color intensity, from black-and-white to full color (not available for adjusting computer images).
- **Tint (in the Video menu)**
Adjusts the balance of magenta to green (not available for adjusting computer images or RGB video images).
- **Color Adjustment (in the Advanced1 menu)**
Adjusts the color temperature. Select **Color Temp.** to set a temperature between 5000 and 10000 °K. Or select **RGB** to adjust individual red, green, and blue values, as shown. (Not available if sRGB is selected as the Color Mode setting.)

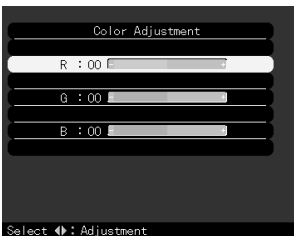



Adjusting the Sound

You can use the Audio menu to adjust the sound volume or treble/bass balance.

1. Press the **Menu** button on the remote control, then enter the **Audio** menu.

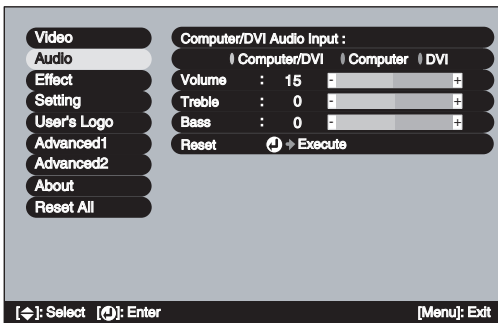
You see the Audio menu screen:



2. Use the  pointer button to highlight the desired option, then adjust it as needed:
 - **Volume**
Adjusts the volume
 - **Treble**
Adjusts the intensity of the treble range
 - **Bass**
Adjusts the intensity of the bass range

note

You can also adjust the volume using the remote control.

Customizing Projector Features

You can use the menu system to change the video signal input at certain ports, turn sleep mode on or off, adjust the network settings, change the language, and customize several other features.

Image Setup Options

Use these settings to change how the projector processes incoming video signals. Several of these settings should normally be left at the factory default setting (except for the **Computer** and **BNC Input** settings).

- **Computer Input (in the Setting menu)**
Select the setting for the type of equipment you've connected to the Computer port:
 - Analog-RGB: For a computer connection
 - RGB-Video: For a video player that outputs an RGB video signal
- **BNC Input (in the Setting menu)**
Select the setting for the type of equipment you've connected to the BNC ports:
 - Analog-RGB: For a computer connection
 - RGB-Video: For a video player that outputs an RGB video signal
 - YCbCr: For a video player that outputs a component video signal
 - YPbPr: For a video player that outputs a component video signal
- **Video Signal (in the Video menu)**
Leave this setting at **Auto** unless you are using a 60-hertz PAL system (select **PAL60**). You can change this setting only if you're displaying an image through the **Video** or **S-Video** port.
- **Progressive (in the Advanced1 menu)**
This setting should normally be left at its default setting (**Video** or **Film/Auto**). Converts interlaced signals to progressive signals. When set to **OFF**, interlaced signals are processed without conversion (available for video signals only).

- **BNC Sync Termination (in the Advanced2 menu)**
This setting should normally be left **Off** (for TTL input). If an analog (75-ohm) terminator is required, as for a switcher, change the setting to **ON**.

Communication Setup Options

These options let you set up the projector so it can be monitored and controlled from a remote computer (see Chapter 5).

- **Standby Mode (in the Advanced1 menu)**
Select **Network ON** to enable the projector to be monitored over a network when it's in standby mode; this setting also lets you view images on an external monitor during standby, if the monitor has been connected to the projector's **Monitor Out** port (see page 23).
- **Network (in the Advanced2 menu)**
Used for managing the projector over a network (see Chapter 5). If the network assigns addresses automatically, turn on **DHCP**. Otherwise, turn off **DHCP** and enter the projector's **IP Address**, **Subnet Mask**, and **Gateway Address**, if applicable.

If you want to monitor the projector using a network management utility, select **SNMP** and enter at least one trap IP address.
- **COM Port (in the Advanced2 menu)**
Used for communicating with a computer running the EMP Link21L utility software. (You can download this utility free of charge from <http://support.epson.com>.) Select **RS-232C** or **USB**, depending on the port that's being used for communication with the computer. Turn off the projector and then turn it back on for the new setting to take effect.

note

*When Standby Mode is set to **Network ON**, the exhaust fan continues to operate after the projector has cooled down. This is normal.*

note

*Press the **Num** button on the remote control to use the number keypad.*

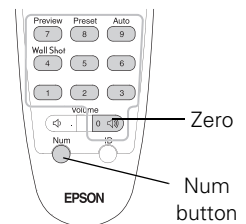

Miscellaneous Setup Options

- **No-Signal Msg. (in the Setting menu)**
Selects a screen color or image to display when the projector is not receiving a signal. The logo setting displays an image that you previously transferred to the projector (see page 57).
- **Sleep mode (in the Setting menu)**
When sleep mode is on, the projector turns off the lamp if it has not received any input signals for 30 minutes. Turn sleep mode off if you want the lamp to remain on all the time (this is the default setting).
- **Message (in the Setting menu)**
Selects whether the image source or the color mode is displayed on the screen.
- **Rear Proj. (in the Advanced1 menu)**
Turn on to project from behind onto a transparent screen.
- **Ceiling (in the Advanced1 menu)**
Turn on when the projector is mounted upside-down from the ceiling.
- **Language (in the Advanced1 menu)**
Select from nine languages to be used for the projector menus.

5 *Managing the Projector from a Remote Computer*

note

A plug-in will be available to allow you to manage your projectors in HP OpenView. Check with your dealer or EPSON for availability (see page 113).

If you're using a network management utility running SNMP, you can configure your network to send trap alerts even without a plug-in (see page 78). This feature is intended for use by network administrators only.

Your projector's Easy Management software lets you monitor and control your projector(s) from a remote computer in several ways:

- Use EMP Monitor to see your projectors' status, switch image sources, and control basic settings.
- Use EMP NetworkManager to receive e-mail notifications alerting you to possible problems.
- Use a network management utility running SNMP, such as HP OpenView,TM to manage your facility's equipment from a pre-existing system.

To use the Easy Management software to manage your projector(s), first install it as described on page 76. Then connect and configure each projector you want to monitor, so it can be recognized on your network (see page 78).

This chapter covers the following information:

- Installing the Easy Management software
- Connecting the projector to and configuring it for the network
- Using EMP Monitor
- Using EMP NetworkManager

Installing the Easy Management Software

The projector software CD-ROM includes the software you need to use the projector's EMP Monitor and EMP NetworkManager.

System Requirements

Before you install the software, make sure your computer meets these requirements:

- Microsoft® Windows 98 SE, XP, 2000, Me, or NT 4.0 (service pack 6a or later)
- Pentium® MMX 166 MHz processor (Pentium II 233 MHz or better recommended)
- At least 256MB of RAM
- At least 7MB of free hard disk space
- XGA (1024 × 768) or better display adapter and monitor

note

The Easy Management software cannot be installed on Macintosh systems.

Installing the Software

Follow these steps to install the software:

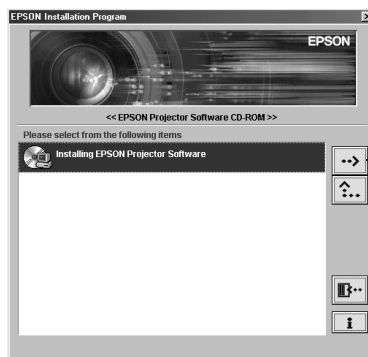

1. Insert the projector software CD-ROM in your computer's CD-ROM drive. You see this screen:



Click here

2. Click the  button to advance to the next screen.



3. If you want to receive e-mail notifications when projector problems occur, make sure **Installing EMP Network Manager** is highlighted, then click the  button. Follow the instructions on the screen to finish installing it.
4. If you want to be able to manage the projector remotely from this computer, select **Installing EMP Monitor** and install it the same way.
5. When done installing the software, click the  button to exit.

Once installed, you can access these programs from your computer's Start menu.

note

If you need to uninstall the software, use the Add/Remove Programs utility in the Windows Control Panel.

Connecting and Configuring the Projector

Before using the Easy Management software to manage your projector(s), you have to connect each projector you want to monitor to your network and configure it with an appropriate IP address.

1. Connect the projector to your network using a commercially available 100baseTX or 10baseT network cable.

Connect the cable to the Ethernet port on the projector as shown.

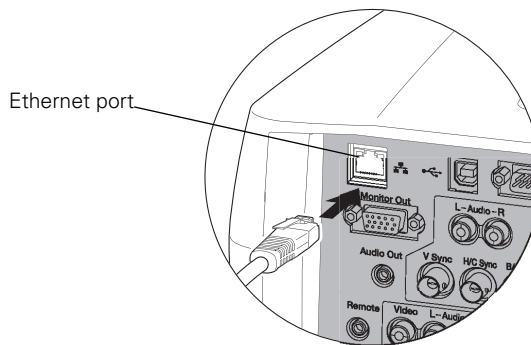

2. Turn on the projector (see page 28).
3. Press the **Menu** button on the remote control and select **Network** from the **Advanced2** menu.

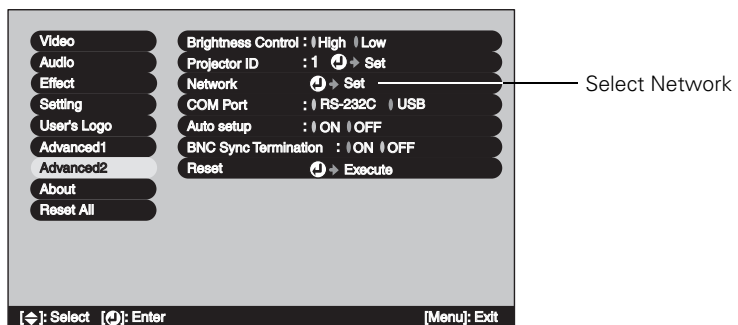

4. If your network assigns addresses automatically, turn on DHCP.

- If your network does not assign addresses automatically, turn off DHCP and enter the projector's IP Address, Subnet Mask, Gateway Address, and MAC Address, as needed.

- To enter numbers using the remote control, press the Num button until it lights, then use the number keypad shown below.

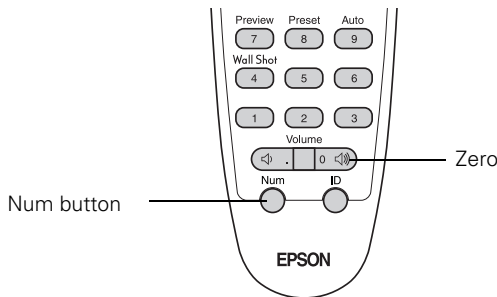

- To change the network addresses from the projector's control panel, press the right and left arrow buttons to select the part of the address you want to enter, then use the up and down arrow buttons to increase or decrease the numeric value.

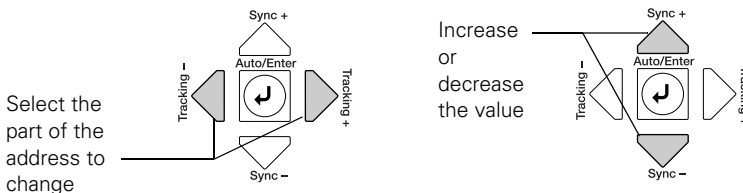

When you finish changing an address in the network menu, press the Enter button (on the remote control) or the **Auto/Enter** button (on the projector). This stores the value.

- When done making all necessary changes, press ESC to exit the menu system.

note

If you're a network administrator, you can use the SNMP option to enter a trap IP address. This lets you receive trap alerts for the projectors you're monitoring. If you have HP OpenView, a plug-in will be available to allow you to manage your projectors in HP OpenView. Check with your dealer or EPSON for availability (see page 113).

Using EMP Monitor

EMP Monitor lets you manage all your projectors using a remote computer. This lets you easily turn the projectors on or off (together or individually), switch image sources, and check on their status.

Before using EMP Monitor, make sure you've installed the software as described on page 76. The computer you're using to monitor the projector should already be connected to your network.

Opening and Closing EMP Monitor

To start EMP Monitor, click **Start > Programs** or **All Programs > EPSON Projector > EMP Monitor**.

If you've added the program to the Startup programs folder (see page 86), then it may already be open. If so, click the icon in the system tray on the lower-right corner of your screen to display the EMP Monitor window:



Click here to start EMP Monitor

To close EMP Monitor, right-click the program icon shown above, then select **Exit**.

Registering a Projector

Before you can monitor a projector, you have to register it. Follow these steps:

1. Click **Start > Programs or All Programs > EPSON Projector > EMP Monitor**. You see this screen:

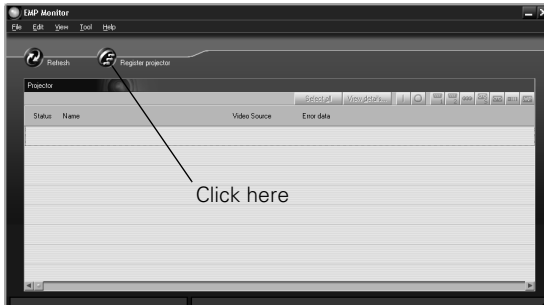

2. Click **Register projector** as shown.

You see this screen:

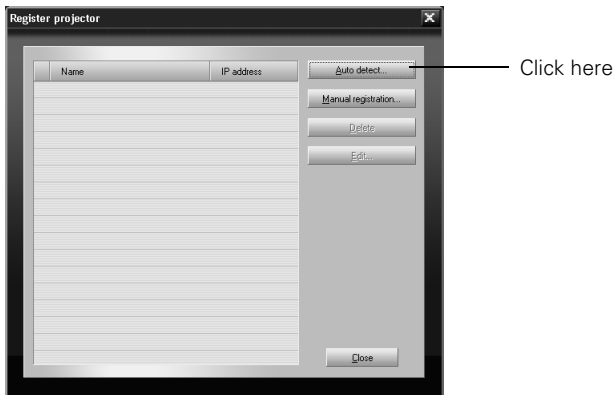

3. Click **Auto detect** to locate projectors currently operating on the network. Or click **Manual registration** and enter the projector's name and network address.

note

If Auto detect fails to find the projector, your projector may not be connected or configured correctly for the network. See page 78.

Any projectors found on the network are listed as shown below:

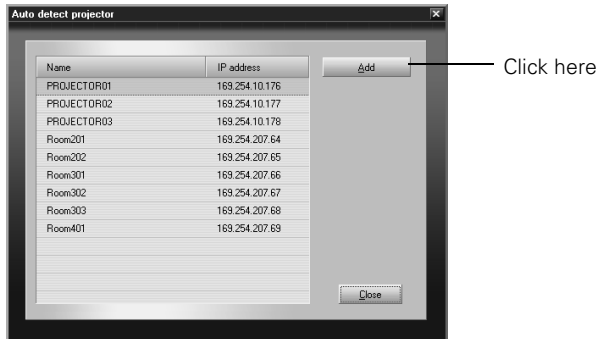

4. Select each projector you want to add by clicking its name, then clicking the **Add** button. When you're done adding projectors, click **Close**.

You see this screen with a list of all registered projectors.

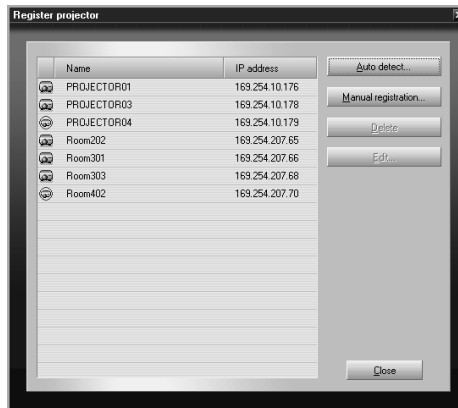

5. Click **Close**.

note

*To delete a projector from the list, highlight the projector name, and click **Delete**.*

You see the status of each of your registered projectors on the main EMP Monitor screen:



Monitoring Your Projectors

The EMP Monitor screen lets you monitor your projectors using the Status, Video Source, and Error icons shown below. This lets you see which projectors are currently being used, from which source (or port) they are projecting an image, and if a problem occurs.



Status icon

Video Source icon

Error icon

For detailed status information, select the projector in question and click View details.

note





To monitor a projector when it's in standby mode (plugged in but not turned on), you must select **Network ON** as the **Standby Mode** setting in the projector's menu system (see page 73).

You can monitor up to 255 projectors.

Remember that when **Standby Mode** is set to **Network ON**, the exhaust fan continues to operate after the projector has cooled down. This is normal.





The following table explains the meaning of the status icons:

Status icons

 (green)	Projecting; no problems
 (dark)	Turned off; no problems
 (green)	Projecting; problems detected
 (dark)	Turned off; problems detected
	Network error (for example, not connected to network, or power cable disconnected). You may also see this error if Network OFF is selected in Standby Mode (see page 73).







The following table explains the meaning of the video source icons:

Video source icons

	Computer
	BNC
	S-Video
	Video
	DVI

The following table explains the meaning of the error icons (see Chapter 7 for recommended solutions to problems):

Error icons

	Lamp replacement notification (the lamp is nearing the end of its life; see page 96)
	High-speed cooling in progress (the projector is getting too hot but continues to operate)
	Overheating (projection turned off automatically)
	Lamp out or lamp cover open
	Fan error
	Sensor error
	Internal problem

Controlling Your Projectors

The control buttons in the upper-right let you turn on and off the projectors and select video sources. (Hold the mouse pointer over a button to see a description of its meaning.) Make sure you've selected the projector you want to operate (with the mouse pointer) before clicking one of the buttons.

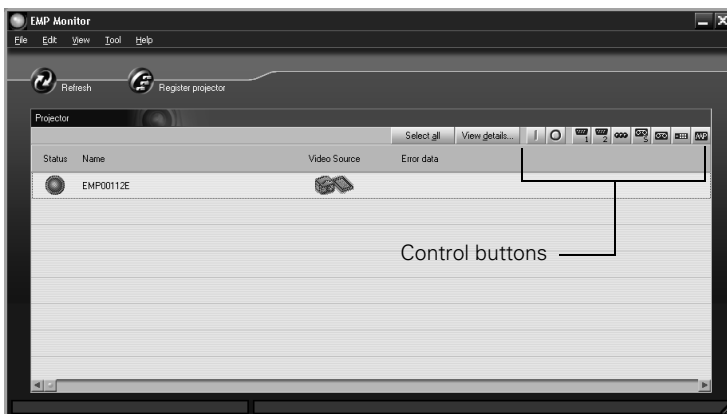

note

*To turn on a projector when it's in standby mode (plugged in but not projecting), you must have selected **Network ON** as the **Standby Mode** setting in the projector's menu system (see page 73).*

*Remember that when **Standby Mode** is set to **Network ON**, the exhaust fan continues to operate after the projector has cooled down. This is normal.*

Configuring the Monitoring Interval

If you need to have the most current status information about your projectors, click the **Refresh** button in the EMP Monitor screen.

You can also select how often EMP Monitor checks the projector status:

1. From the Tool menu, select **Configuration**.

You see this screen.

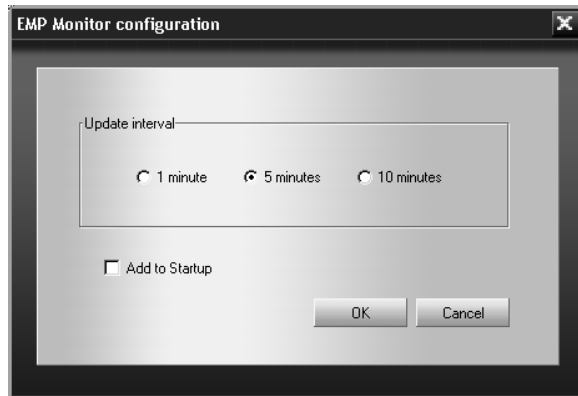

note

*If you want EMP Monitor to run whenever you start your computer, click **Add to Startup**.*

2. Select the desired update interval and click **OK**.

Using EMP NetworkManager

You can use EMP NetworkManager to send out messages by e-mail, notifying you when a problem occurs with a projector. Before running EMP NetworkManager, make sure you've installed the software as described on page 76. Then follow the steps below to create e-mail settings for each projector you want to monitor.

Selecting the Projectors to Monitor

1. To start EMP NetworkManager, click **Start > Programs** or **All Programs > EPSON Projector > EMP NetworkManager**.

You see the EMP NetworkManager screen. The projectors you've already registered through EMP Monitor appear as icons.

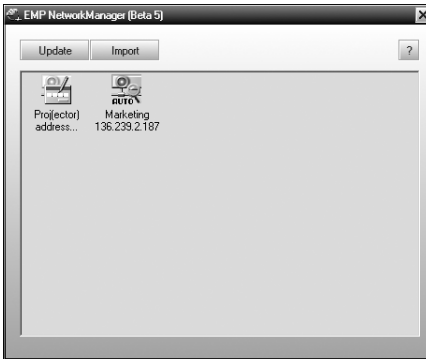

2. If you'd like to register a projector manually and you know its IP address, double-click the  Proj(ector) address selection icon.

You see this screen:

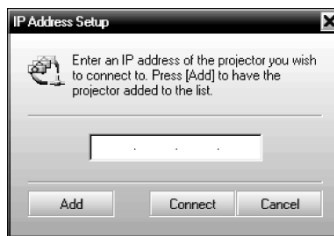

3. Enter the projector's IP address and click **Add**. The projector's icon is added to the EMP NetworkManager screen.

Setting a Password

You can set a password to restrict access to each projector from EMP NetworkManager:

1. Right-click the icon of the projector whose password you want to set, then select **Change Password**.

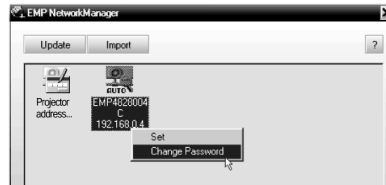

2. Enter a password up to 14 characters in length.

Creating the E-Mail Settings

1. If EMP NetworkManager is not already running, open it from the Start menu.

You see your registered projectors displayed as shown:

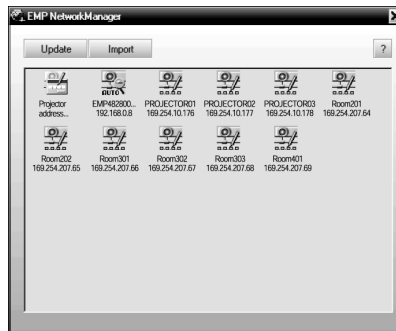

2. Double-click the icon for the projector whose e-mail settings you want to create. Enter your password, if you created one (see above).

3. EMP NetworkManager connects to the projector, and you see this screen:

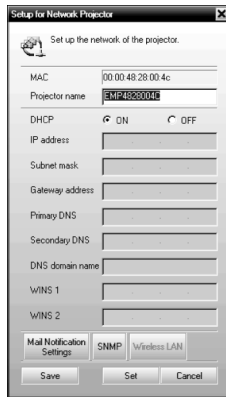

4. Verify that the network settings are correct. (If DHCP is on, you don't need to verify network settings.)

- Make any desired changes to the projector's network address configuration (turning off DHCP enables the manual settings).

- You can give the projector a name—up to 15 characters long, including the following symbols: ! @ # \$ % ^ & ' . - _ { } ~

Naming the projector helps you identify it in EMP Monitor and EMP NetworkManager, especially if you're managing more than a few of them.

5. Click Mail Notification Settings.

You see this screen:



note

The projector must be plugged in (projecting or in standby mode) for you to be able to connect to it.

*To access a projector in standby mode, you must select **Network ON** as the **Standby Mode** setting in the projector's menu system (see page 73).*

*Remember that when **Standby Mode** is set to **Network ON**, the exhaust fan continues to operate after the projector has cooled down. This is normal.*

note

A no-signal message is reported when no image signals are being input to a projector. If the projector will not normally be displaying an image, do not select 'no signal' as a condition for which you want a message to be sent.

6. Select **ON** for the Mail Notification setting.
7. Enter the IP address and port number of the SMTP server used for sending e-mail. (The port's default setting is 25, but you can enter any number from 1 to 65535.)
8. Enter up to three e-mail addresses where you want the event notification messages to be sent.
9. Click the **Setting a Notification Event** button next to each address, then select the conditions under which you want a message to be sent.
10. Click **OK**, then click **OK** again on the next screen. Click **Set** on the Setup for Network Projector screen and confirm as needed.
11. When you see the test message window, you can send a message with the heading "TEST MAIL" to the addresses you have entered. The projector's name and IP address are included in the body of the message.
12. When done making all your projector settings, close EMP NetworkManager. (It does not have to be open for messages to be sent or received.)

Understanding the Notification Messages

If a projector experiences a problem, it sends an e-mail message to each of the addresses you provided using EMP NetworkManager. The message includes the heading “EPSON Projector” in the subject line.

The body of the message contains:

- the name of the projector
- the projector’s IP address
- a description of the problem

The problem descriptions are similar to the errors reported by EMP Monitor listed on page 85.

If a plus (+) sign appears before the description, it indicates that a problem has occurred. A minus (–) sign appears when the problem goes away or is resolved.

note

If a projector develops a critical problem, it may not be possible for it to report the error.

6

Maintaining the Projector

Your projector needs little maintenance. All you have to do on a regular basis is keep the lens clean. Any dirt or smears on the lens may show up on your projected image.

You also need to periodically clean the air filters at the side and base of the projector. A clogged air filter can block ventilation needed to cool the projector.

The only parts you should replace are the lamp and air filters (when you order a new lamp, replacement filters come with it). If any other part needs replacing, contact your dealer or a qualified servicer.

This chapter covers the following:

- Cleaning the lens
- Cleaning the projector case
- Cleaning the air filters and vents
- Replacing the lamp and air filters
- Transporting the projector

warning

Before you clean any part of the projector, turn it off and unplug the power cord.

Never open any cover on the projector, except the lamp cover. Dangerous electrical voltages in the projector can injure you severely. Do not try to service this product yourself, except as specifically explained in this User's Guide. Refer all other servicing to qualified service personnel.

Cleaning the Lens

Clean the lens whenever you notice dirt or dust on the surface.

- Use a canister of compressed air to remove dust.
- To remove dirt or smears on the lens, use lens-cleaning tissue. If necessary, moisten a soft cloth with lens cleaner and gently wipe the lens surface.

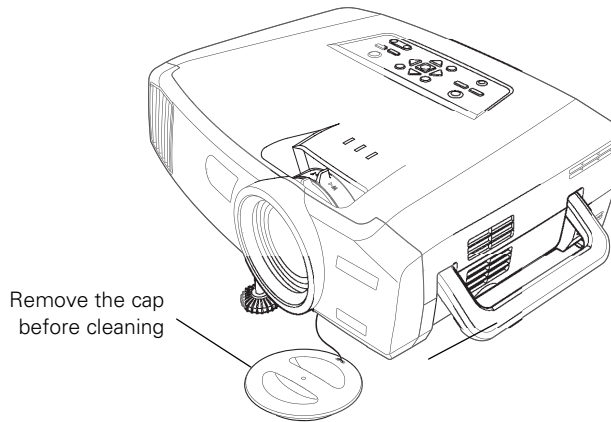

Cleaning the Projector Case

Before you clean the case, first turn off the projector and unplug the power cord.

- To remove dirt or dust, wipe the case with a soft, dry, lint-free cloth.
- To remove stubborn dirt or stains, moisten a soft cloth with water and a neutral detergent. Then wipe the case.
- Do not use wax, alcohol, benzene, thinner, or other chemical detergents. These can damage the case.

Cleaning the Air Filters and Vents

Clean the air filters and air intake vents after every 100 hours of use. If they are not cleaned periodically, they can become clogged with dust, preventing proper ventilation. This can cause overheating and damage the projector.

Follow these steps:

1. Turn off the projector and unplug the power cord.
2. To clean the intake vents, EPSON recommends using a small vacuum cleaner designed for computers and other office equipment. If you don't have one, gently clean the vents with a soft brush (such as an artist's paintbrush).

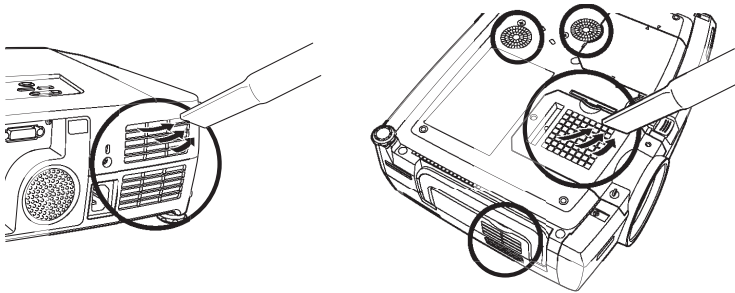

3. Gently turn the projector over and remove the filters from the side and bottom of the projector. Then use a small vacuum cleaner or soft brush to clean the filters. Slide the filters back into place when you're done.

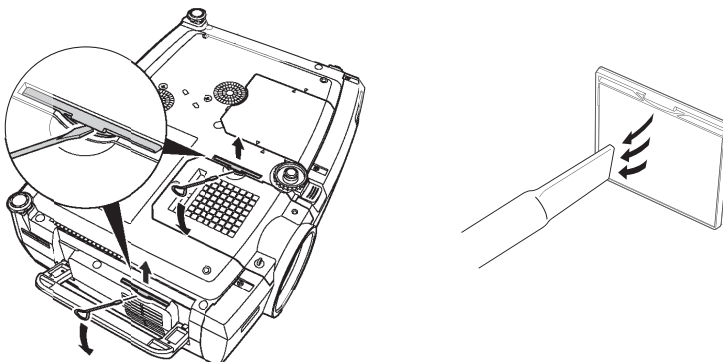

4. If the dirt is difficult to remove or a filter is broken, replace the filters as described on the next page. Contact your dealer or call EPSON at (800) 873-7766 in the United States to obtain new ones. In Canada, please call (800) 463-7766 for dealer referral.

Replacing the Lamp and Air Filters

note

When you get a replacement lamp for your projector, new air filters are included. You should replace the filters when you replace the lamp.

You can check how long the lamp has been in use (see page 99).



warning

Let the lamp cool fully before replacing it.

In the unlikely event that the lamp has broken, small glass fragments may be present and should be removed carefully to avoid injury.

The projection lamp typically lasts from 2000 to 3000 hours, depending on the Brightness Control setting used (see page 66). Selecting the low brightness setting maximizes the lamp's life.

It is time to replace the lamp when:

- The projected image gets darker or starts to deteriorate.
- The message **LAMP REPLACE** appears on the screen when the lamp comes on and the lamp warning light  flashes orange. To maintain projector brightness and image quality, replace the lamp as soon as possible.
- The lamp warning light  flashes red (the lamp is burnt out).

Contact your dealer or call EPSON at (800) 873-7766 in the United States for a replacement lamp. Request part number V13H010L22. In Canada, please call (800) 463-7766 for dealer referral.

Follow these steps to replace the lamp and air filters:

1. Turn off the projector.
2. When the power light stops flashing, unplug the power cord.
3. Let the projector cool for at least half an hour (if it has been on). The lamp is extremely hot immediately after use.

4. Turn the projector over and remove the air filters at the side and bottom of the projector.

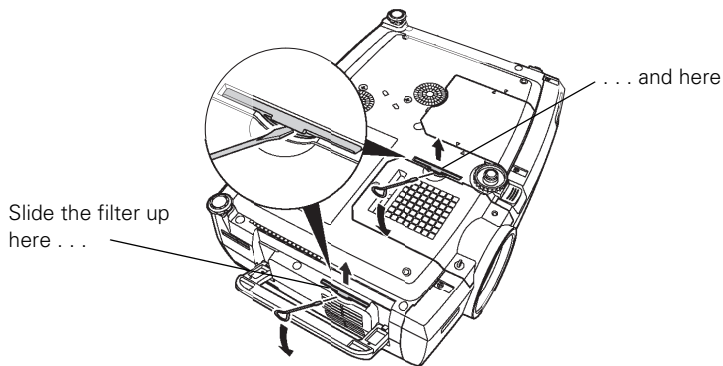

5. Insert the two new air filters. They should click into place.
6. Insert the screwdriver supplied with the spare lamp, or some other flat-tipped screwdriver, into the space beside the air vent. Gently slide the lamp cover off.

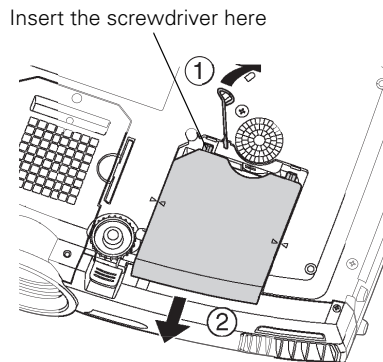

7. Loosen the two screws holding the lamp in place (you don't need to remove them).

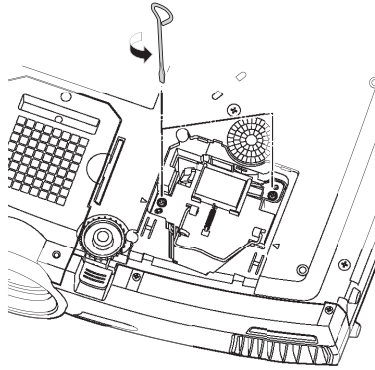

8. Grasp the wire handle as shown and pull the lamp straight out.

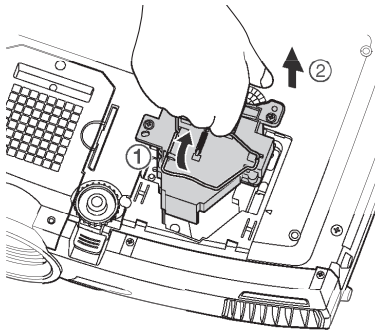

note

When you get a replacement lamp for your projector, new air filters are included. This is a good time to install them (see page 96).

9. Gently insert the new lamp.
10. Once the lamp is fully inserted, tighten its screws and replace the cover. (The projector won't come on if the lamp cover is loose.)
11. Reset the lamp timer as described in the next section.

Resetting the Lamp Timer

After you replace the lamp, you need to reset the lamp timer using the projector's menu.

1. Press the **Menu** button on the remote control (or on the projector's control panel). You see the main menu.
2. Use the  pointer button on the remote control (or the arrow buttons on the projector) to highlight **About**, then press **Enter**.

You see this screen:

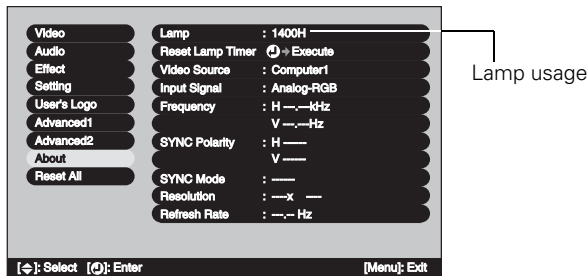

note

The lamp usage timer shows OH until you've used the lamp for at least 10 hours.

3. Select **Reset Lamp Timer**, then press **Enter**. You see this prompt:

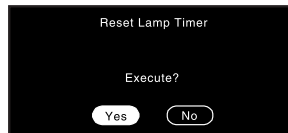

4. Select **Yes**, then press **Enter**.
5. When you're finished, press **ESC** or **Menu** to exit.

Transporting the Projector

The projector contains many glass and precision parts. Follow these guidelines to prevent injury or damage:

- When hand-carrying the projector, you should use the handle to lift it only a short distance (for example, to set it on a table).
- When shipping the projector for repairs, use the original packaging material if possible. If you do not have the original packaging, use equivalent materials, placing plenty of cushioning around the projector.
- When transporting the projector a long distance, first place it in a hard-shell shipping case, and then pack it in a firm box, placing cushioning around the case. (An optional ATA molded hard shell case is available from EPSON; see page 6.)

note

EPSON shall not be liable for any damages incurred during transportation.

7

Solving Problems

This chapter helps you solve problems with your projector, and tells you how to contact technical support for problems you can't solve yourself. This chapter explains the following:

- Using the projector's on-screen help system
- What to do when the projector's status lights flash
- Solving problems with the image or sound
- Solving problems with Easy Management
- Solving problems with the remote control
- Contacting technical support

Using On-Screen Help

If the image doesn't look right or your audio isn't working, you can get help by pressing the blue ? Help button on top of the projector or on the remote control. The following choices are available:

- Help for the image
- Help for the sound
- Language selection (Language)

Follow these steps to get help:

1. Press the blue ? Help button on the projector.

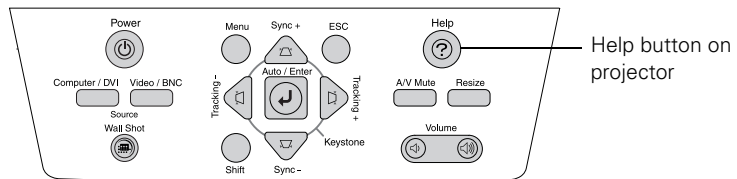

You see the Help menu:

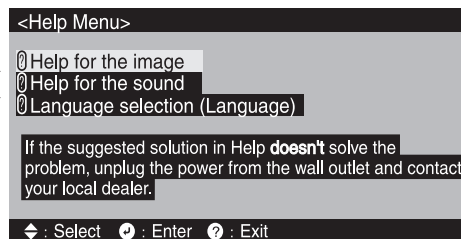

2. Use the  pointer button on the remote control or the arrow buttons on the projector to highlight menu items.
3. After highlighting a menu item, press the Enter button on the remote control or on the projector to select it.
4. To exit the Help system, press the ? Help button.

If none of the suggestions solves your problem, see additional solutions to problems in the following sections.

Checking Projector Status

If your projector isn't working correctly, first turn it off, wait for it to cool (the  power light stops flashing orange), and unplug it. Then plug the power cord back in and turn on the projector. If this doesn't solve the problem, check the lights on top of the projector.



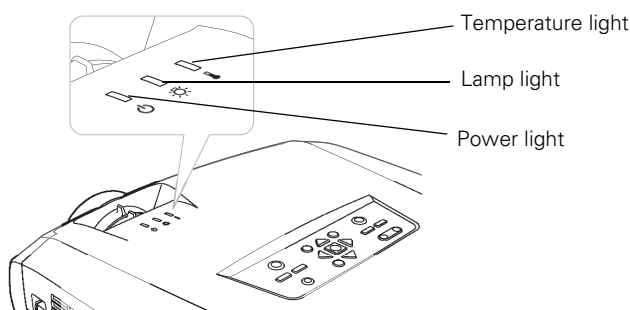

What To Do When the Lights Flash

The lights on top of the projector indicate the projector's status and let you know when a problem occurs.







Refer to the following table for a complete description of the projector's status lights and their meaning:

Status lights

Light	Status	Description
	orange	The projector is in sleep mode. You can unplug it or press the Power button to turn it on.
	flashing green	The projector is warming up. Wait for the image to appear.
	green	The projector is operating normally.
	flashing orange	The projector is cooling down. You can't turn it back on (and you should not unplug it) until the light stops flashing and remains orange.
	flashing red	There is a problem with the fan or temperature sensor. Stop using the projector, disconnect the power cable, and contact EPSON or your dealer.

Status lights

Light	Status	Description
	flashing orange	Rapid cooling in progress. Although this is not an abnormal condition, projection will stop automatically if the temperature rises too high again. Make sure there is plenty of space around and under the projector for ventilation, and that the air filters and vents are clear.
	red	<p>The projector is overheating, which turns the lamp off automatically. Wait until the cooling fan stops, then unplug the power cord. Plug the power cord back in and press the Power button. Make sure the room temperature is not above 95 °F (35 °C) and there is plenty of space around and under the projector for ventilation.</p> <p>The air filters may be clogged. Clean or replace them as described on page 95.</p> <p>If the projector continues to overheat after you clean the air filter, the problem may be caused by damage to the cooling fan or temperature sensor. Contact EPSON for help.</p> <p>Warning: Except as specifically explained in this <i>User's Guide</i>, do not attempt to service this product yourself.</p>
	flashing orange	It's time to replace the lamp. See page 96 for instructions. If you continue to use the lamp after the replacement warning, there is an increased possibility that the lamp may break.
	flashing red	The lamp may be burned out. First make sure the lamp cover is securely installed. If that's not the problem, remove the lamp and replace it as described on page 96. If this does not resolve the problem, contact EPSON as described on page 113.
	flashing red	Power is cut off because of an internal problem. Remove the power cord and contact EPSON for help, as described on page 113.

The power light is flashing orange and you cannot turn on the projector.

The lamp is cooling down. Wait until the light turns off and then press the **Power** button to turn on the projector.

The power light does not come on.

Make sure the power cord is connected securely both at the power outlet and the projector. If you have just replaced the lamp, make sure the cover is securely fastened.

Viewing Lamp Usage and Other Information

Use the About menu to view information about the display settings of your computer and the number of hours the lamp has been used.

1. Press the **Menu** button, then highlight the **About** menu and press **Enter**.

You see the lamp usage hours and various input signal settings on the right:

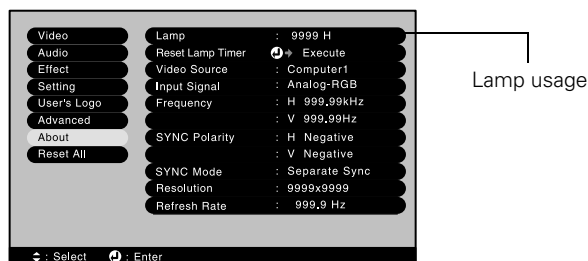



note

The information displayed depends on the input signal currently selected.

The lamp typically lasts from 2000 to 3000 hours, depending on the selected Brightness Control setting (see page 66). If the number shown is close to that, make sure you have a spare lamp handy. If you've installed a new lamp, be sure to reset the lamp timer (see page 99).

Solving Problems with the Image or Sound

No image appears on the screen.

- Check that the  power light is green, not flashing, and the lens cap is off.
- The projector may be in sleep mode. If the  power light is orange, press the **Power** button to turn the projector on.
- If the power was switched off and then on again, the projector may still be cooling down. Wait until the power light stops flashing and remains orange; then press the **Power** button again.
- Try pressing the other **Power** button on the remote control or on the projector.
- Press the **A/V Mute** button to make sure the picture has not been turned off temporarily.
- The attached computer may be in sleep mode or displaying a black screen saver. Try pressing a key on the computer.

You've connected a computer and see a blue screen with the message No Signal displayed.

- Make sure the cables are connected correctly, as described in Chapter 1.
- Try restarting your computer.
- If you've connected a computer and one or more video sources, you may need to press one of the **Source** buttons on the projector or remote control to select the correct source. Allow a few seconds for the projector to sync up after pressing the button.

If you're using a PC laptop:

- Hold down the Fn key on the keyboard and press the function key that lets you display on an external monitor. It may have an icon such as , or it may be labelled CRT/LCD. Allow a few seconds for the projector to sync up after pressing it. Check your laptop's manual or online help for details.

On most systems, the  key lets you toggle between the LCD screen and the projector, or display on both at the same time.

- Depending on your computer's video card, you might need to use the Display utility in the Control Panel to make sure that both the LCD screen and external monitor port are enabled. See your computer's documentation or online help for details.

If you're using Macintosh OS 8.6 to 9.x:

1. From the Apple menu, select **Control Panels**, then click **Monitors and Sound**.
2. Click the **Arrange** icon.
3. Drag one monitor icon on top of the other. This lets you display on the projector screen as well as the LCD screen.
4. If this option isn't available, click the **Monitor** icon.
5. Select one of the listed **Simulscan** resolutions. (Allow a few seconds for the projector to sync up after making the selection.)

If you're using Macintosh OS X:

1. Open **System Preferences**.
2. Double-click **Displays**.
3. Make sure the **VGA Display** or **Color LCD** dialog box is selected.
4. Click the **Arrange** tab.
5. Make sure the **Mirror Displays** checkbox is selected.

The message Not Supported is displayed.

- Make sure the correct **Input Signal** is selected in the Setting menu (see page 72).
- Make sure your computer's resolution doesn't exceed UXGA (1600 × 1200), and the frequency is supported by the projector (see page 120). If necessary, change your computer's resolution setting as described on the following page.

Only part of the computer image is displayed.

- Press the **Auto** button on the remote control.
- Make sure the image **Position** setting is correct on the Video menu. See Chapter 4 for more information.
- Make sure your computer's resolution setting is correct. Ideally, it should be 1024 × 768 to match the projector's native resolution. If this option isn't available, select one of the other compatible video formats listed on page 120.
 - **Windows:**
Right-click the desktop, select **Properties**, click the **Settings** tab, and select a different resolution.
 - **Macintosh OS 8.6 to 9.x:**
On the Apple menu, choose **Control Panels**, then click **Monitors and Sound**. Select a different resolution.
 - **Macintosh OS X:**
Open **System Preferences**, double-click **Displays**, and then select a different resolution.
- You also may need to modify existing presentation files if you created them for a different resolution. See your software documentation for specific information.

The image isn't square, but keystone-shaped.

- If the top or bottom of the image is broader, press the **Sync +** or **Sync -** button on the projector until the image is square.
- If the projector is angled toward the screen from the left or right, the image will be broader on one side. Center the projector in front of the middle of the screen, facing the screen squarely. If this doesn't work, press the **Tracking +** or **Tracking -** button on the projection until the image is square.
- If the image is trapezoid-shaped (no parallel sides), use **Quick Corner**. Press the **Menu** button, select the **Setting** menu, then select **Keystone**. Finally, select **Quick Corner** and make your adjustments with the  pointer button. See page 37 for details.

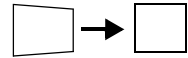
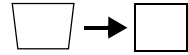

The image contains static or noise.

- Make sure the correct **Input Signal** is selected in the **Setting** menu (see Chapter 4).
- If you're using a computer cable longer than 6 feet (2 meters), or an extension cable, the image quality may be reduced.
- Keep your computer and video cables away from the power cord as much as possible to prevent interference.
- The video signal may be split between the computer and the projector. If you notice a decline in the projected image quality when the image is displayed simultaneously on your laptop computer and the projector, turn off the laptop's LCD display.

The image is blurry.

- There may be dirt or smears on the lens. Clean the lens as described on page 94.
- Adjust the focus using the focus ring.
- Make sure the lens is not fogged by condensation. You may need to wait before using the projector after moving it from a cold environment to a warm environment.

- Adjust the **Sharpness** setting on the Video menu (see Chapter 4). When you change video settings, you should be able to see the effect on the screen immediately. If you're projecting from a computer, you may also need to adjust the tracking and sync as described in the next section. If you don't like the new settings, you can always select **Reset** to return to the factory default settings.

You see vertical stripes, or the image still looks blurry after trying the solutions in the previous section.

- If you're projecting from a computer and displaying an image that contains a lot of fine detail, you may notice one or more vertical stripes or bands, or some of the characters may look heavy or blurred. Press the **Auto** button on the remote control. This resets the projector's tracking and sync settings.
- If further adjustment is needed, you can fine-tune the **Tracking** and **Sync** settings manually using the Video menu as described in Chapter 4.
 1. Fill the screen with an image containing fine detail when making these adjustments. For example, in Windows you can select a pattern to appear as your desktop background. If this option isn't available, try projecting black text on a white background.
 2. Adjust the **Tracking** to eliminate vertical stripes.

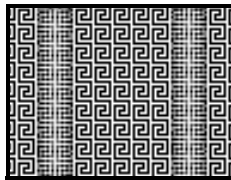

3. Adjust the **Sync** setting to increase the sharpness of the image.

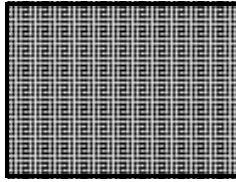



The colors of the image are not right.

- If you're displaying a computer image, use the **Color Mode** option in the projector's Video menu to adjust the color. If you're displaying video, adjust the **Color**, **Tint**, and **Color Mode** settings on the Video menu.
- Try changing the **Color Adjustment** setting on the Advanced1 menu.
- Check your computer display settings to correct the color balance.

note

Because of the different technologies used, your projected image may not exactly match the colors on your laptop or computer monitor.

There is no sound.

- Make sure the **A/V Mute** button is not enabled.
- Try adjusting the **Volume** setting in the Audio menu (see page 71).
- If you're using a VCR or other video source, make sure the volume is not turned all the way down or muted. Also, make sure the cables are connected correctly, as described in Chapter 1.
- If your presentation includes computer audio, make sure the volume control on your computer is not turned all the way down or muted. If you're using the audio cable, make sure it is securely connected to both the projector and your computer's  headphone jack or  audio out jack.
- Make sure the Windows volume controls on your computer are not turned all the way down or set to Mute. You may be able to check this by clicking the volume control in your Windows System Tray (lower right corner of the screen).

Solving Easy Management Problems

You don't see your projector in the EMP Monitor window.

- Make sure that you've connected the projector to the network and configured it correctly; see page 78. Also, make sure you've registered the projector with EMP Monitor. See page 81.
- Make sure that Standby Mode in the Advanced1 menu is set to Network ON.
- If the computer you are using is running Windows XP, 2000, or NT 4.x, you must be logged in as the Administrator.
- Try restarting your computer.

Solving Problems with the Remote Control

The projector doesn't respond to remote control commands.

- If you're using the remote control for the first time, be sure to push up on the on/off switch, as shown on page 46.
- The remote control's battery may not be installed correctly or may be low on power. To change the battery, see page 48.
- Make sure your remote control's ID is set to 0, or to the projector's ID. See page 61.
- Make sure you are within 33 feet (10 meters) of the projector, and within range of the projector's front or back sensor (approximately 30° to the left or right and 15° above or below).
- Dim the room lights and turn off any fluorescent lights. Make sure the projector is not in direct sunlight. Strong lighting, especially fluorescent lights, may affect the projector's infrared receivers. Also, turn off any nearby equipment that emits infrared energy, such as a radiant room heater.

Where To Get Help

EPSON provides technical assistance through electronic support services 24 hours a day, as listed in the following table.

Service	Access
World Wide Web	From the Internet, you can reach EPSON's product support page at http://support.epson.com . After selecting your product, you can access troubleshooting information, download product documentation, and receive technical advice through e-mail.
Presenters Online	Access tips, templates, and training for developing successful presentations at http://www.presentersonline.com

Telephone Support Services

To use the EPSON PrivateLine Support service, call (800) 637-7661 and enter the PIN on the EPSON PrivateLine Support card included in your Start Here kit. This is the fastest way of speaking to a live representative, and it's free. This service is available 6 AM to 6 PM, Pacific Time, Monday through Friday, for the duration of your warranty period.

You may also speak with a projector support specialist by dialing one of these numbers:

- U.S.: (562) 276-4394, 6 AM to 6 PM, Pacific Time, Monday through Friday
- Canada: (905) 709-3839, 6 AM to 6 PM, Pacific Time, Monday through Friday

Toll or long distance charges may apply.

Before you call, please have the following information ready:

- Product name (EPSON PowerLite 7800p)
- Product serial number (located on the bottom of the projector)
- Computer configuration
- Description of the problem

You can purchase screens, carrying cases, or other accessories from EPSON at (800) 873-7766 or by visiting the EPSON Store at www.epsonstore.com (U.S. sales only). In Canada, please call (800) 463-7766 for dealer referral.

A

Appendix A: Projector Installation

This appendix provides guidelines on installing the projector in a permanent location, such as a theater or conference room.

Installation Guidelines

The projector can be installed for four different viewing setups: front projection, ceiling mounting, rear projection onto a semi-transparent screen, or rear/ceiling projection, as shown:

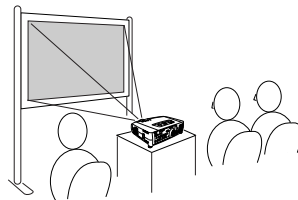

Front projection

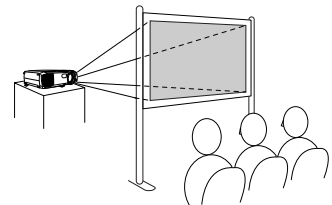

Rear projection

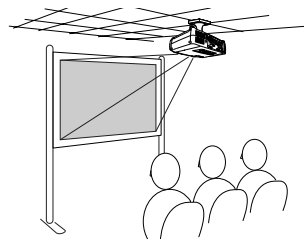

Ceiling mounting

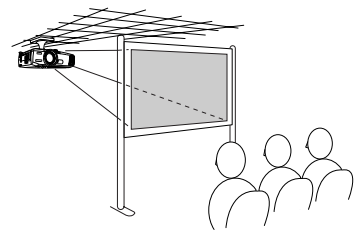

Rear/ceiling projection

To project from overhead, you'll need the optional ceiling mounting hardware; see page 6 for ordering information. You'll also need to select **Ceiling** in the projector's Advanced1 menu to flip the image upside-down. To project from the rear, select **Rear Proj** (see page 74).

If you're mounting the projector on the ceiling and you place it above screen level, you'll have to tilt it down to position the image on-screen. This causes the image to lose its square shape. You can then correct the distortion by using the **Keystone** function in the projector's menu system (see page 69) or by using the **Keystone** buttons on the projector's control panel.

If you place the projector so that the base of the lens is level with the bottom of the screen, the image will be square and you won't have to adjust it. If you place the lens lower than the bottom of the screen, you'll have to tilt the projector upward if you want to fill the whole screen with the image.

If you want to be able to control the projector's settings from a remote computer, see Chapter 5.

You can also use the remote control to operate more than one projector. See page 60.

B

Appendix B: Technical Specifications

General

Type of display	Poly-silicon TFT active matrix
Size of LCD panels	Diagonal: 1.0 inch (25.4 mm)
Lens	F=1.7 to 2.3, f=28 to 37 mm
Resolution (native format)	1024 × 768 pixels (XGA)
Color reproduction	24 bit, 16.7 million colors
Brightness	3500 lumens (ANSI)
Contrast ratio	700:1
Image size	30 to 300 inches
Projection distance	2.6 to 36.1 feet (0.8 to 11 meters)
Projection methods	Front, rear, upside-down (ceiling mount)
Internal sound system	5 W monaural
Optical aspect ratio	4:3 (horizontal:vertical)
Zoom ratio	1:1.35
Noise level	36 dB
Keystone correction	Automatic with manual adjustment capability, ±40° (vertical), ±20° (horizontal)

Projection Lamp

Type	UHE (Ultra High Efficiency)
Power consumption	250 W
Lamp life	Up to 2000 hours (high brightness mode) Up to 3000 hours (low brightness mode)
Part number	V13H010L22

Remote Control

Range	33 feet (10 meters)
Batteries (2)	Alkaline size AA

Mouse Compatibility

Supports USB

Dimensions

Height	4.6 inches (117 mm), feet retracted
Width	16.5 inches (419 mm)
Depth	12.8 inches (325 mm)
Weight	12.1 lb (5.5 kg)

Electrical

Rated frequency	50/60 Hz AC
Power supply	100 to 120 VAC, 3.6 A 200 to 240 VAC, 1.6 A
Power consumption	Operating: 350 W Standby: 1.5 W with Network OFF 47 W with Network ON

Environmental

Temperature	Operating: 41 to 95 °F (5 to 35 °C) Storage: 14 to 140 °F (-10 to 60 °C)
Humidity	Operating: 20 to 80% RH, non-condensing Storage: 10 to 90% RH, non-condensing

Safety

United States	FCC 47CFR Part 15B Class B (DoC) UL1950 Rev. 3
Canada	ICES-003 Class B CSA C22.2 No. 950-95 (cUL)
CE Marking	Directive 73/23/EEC Directive 89/336/EEC EN 55022, EN 55024

Compatible Video Formats

The projector supports NTSC, PAL, and SECAM international video standards, as well as the monitor display formats listed below.

To project images output from a computer, the computer's video card must be set at a refresh rate (vertical frequency) that's compatible with the projector; see the following table for compatible formats. As noted below, some images are automatically resized to display in one of the projector's "native" formats (such as XGA). In addition, the frequencies of some computers may not allow images to display correctly; see your computer's documentation for details.

Mode	Refresh Rate (Hz)	Resolution
VGAEGA	70	640 × 350*
VGA—60	60	640 × 480*
VESA—72	72	640 × 480*
VESA—75	75	640 × 480*
VESA—85	85	640 × 480*
SVGA—56	56	800 × 600*
SVGA—60	60	800 × 600*
SVGA—72	72	800 × 600*
SVGA—75	75	800 × 600*
SVGA—85	85	800 × 600*
XGA—60	60	1024 × 768
XGA—70	70	1024 × 768
XGA—75	75	1024 × 768
XGA—85	85	1024 × 768
XGA—100	100	1024 × 768
XGA—120	120	1024 × 768
SXGA1—70	70	1152 × 864
SXGA1—75	75	1152 × 864
SXGA1—85	85	1152 × 864
SXGA1—100	100	1152 × 864
SXGA2—60	60	1280 × 960*
SXGA2—75	75	1280 × 960*
SXGA2—85	85	1280 × 960*
SXGA3—60	60	1400 × 1050*
SXGA3—75	75	1400 × 1050*
SXGA3—85	85	1400 × 1050*

Mode	Refresh Rate (Hz)	Resolution
UXGA—60	60	1600 × 1200*
UXGA—65	65	1600 × 1200*
UXGA—70	70	1600 × 1200*
UXGA—75	75	1600 × 1200*
UXGA—80	80	1600 × 1200*
UXGA—85	85	1600 × 1200*
MAC13	67	640 × 480*
MAC16	75	832 × 624*
MAC19	75	1024 × 768
MAC21	75	1152 × 870*
NTSC	60	—
NTSC 4:43	60	—
PAL	50	—
N-PAL	50	—
M-PAL	60	—
PAL—60	60	—
SECAM	50	—
HDTV (720p)	60	1024 × 576*
HDTV (1080i)	60	1024 × 576*
SDTV (480i)	60	1024 × 768
SDTV (480p)	60	1024 × 768
SDTV (625i)	50	1024 × 768
SDTV (625p)	50	1024 × 768

*The image is resized using EPSON's SizeWise™ Technology.

C

Appendix C: Notices

This appendix includes safety instructions and other important information about your EPSON PowerLite projector.

Important Safety Instructions

Follow these safety instructions when setting up and using the projector:

- Do not place the projector on an unstable cart, stand, or table.
- Do not use the projector near water or sources of heat.
- Use the type of power source indicated on the projector. If you are not sure of the power available, consult your dealer or power company.
- Place the projector near a wall outlet where the plug can be easily unplugged.

Placez l'appareil près d'une prise de courant où la fiche peut être débranchée facilement.

- Insert the projector's three-wire grounding-type plug into a properly grounded outlet. If you have a two-prong outlet, contact an electrician to replace it. Do not hold the plug with wet hands.
- Take the following precautions for the plug. Failure to comply with these precautions could result in sparks or fire: Do not insert the plug into an outlet with dust present. Insert the plug firmly into the outlet.
- Do not overload wall outlets, extension cords, or integral convenience receptacles. This can cause fire or electric shock.
- Do not place the projector where the cord can be walked on. This may result in fraying or damage to the plug.
- Unplug the projector from the wall outlet before cleaning. Use a damp cloth for cleaning. Do not use liquid or aerosol cleaners.
- Do not block the slots and openings in the projector case. They provide ventilation and prevent the projector from overheating. Do not operate the projector on a sofa, rug, or other soft surface, or in a closed-in cabinet unless proper ventilation is provided.

- Never push objects of any kind through the cabinet slots. Never spill liquid of any kind into the projector.
- Except as specifically explained in this *User's Guide*, do not attempt to service this product yourself. Refer all servicing to qualified personnel. Opening or removing covers may expose you to dangerous voltages and other hazards.
- Unplug the projector from the wall outlet and refer servicing to qualified service personnel under the following conditions: When the power cord or plug is damaged or frayed. If liquid has been spilled into the projector, or if it has been exposed to rain or water. If it does not operate normally when you follow the operating instructions, or if it exhibits a distinct change in performance, indicating a need for service. If it has been dropped or the housing has been damaged.
- This product includes a lamp component that contains mercury. Please consult your state and local regulations regarding proper disposal and do not place in the trash.
- Unplug the projector during lightning storms or when it will not be used for extended periods.
- Do not place the projector and/or remote control on top of heat-producing equipment or in a hot location.
- If you use the projector in a country other than where you purchased it, use the correct power cord for that country.
- Do not stand on the projector or place heavy objects on it.
- Do not use the projector outside of the required temperature range of 41 to 95 °F (5 to 35 °C). Doing so may cause an unstable display and could lead to projector damage.
- Do not store the projector outside of the required temperature range of 14 to 140 °F (-10 to 60 °C) or in direct sunlight for long periods of time. Doing so may cause damage to the case.

Remote Control Information

You can operate the projector by remote control via a line-of-sight infrared (IR) receiver at the front and rear of the projector. The projector may not respond to remote control commands under the following conditions:

- There is an object between the remote control IR emitter and the IR receiver on the projector.
- Ambient light is too bright.
- Certain types of fluorescent lighting are used.
- A strong light source shines into the IR receiver.
- Other equipment that emits infrared energy, such as a radiant room heater, is in the room.

These conditions commonly cause problems for most infrared-controlled equipment. Try the following:

- The remote control's battery may be low on power; replace it.
- Dim the ambient lighting and/or turn off any fluorescent lights.
- Close any window coverings and/or move the projector out of direct sunlight.
- Turn off other equipment that emits infrared energy.

Declaration of Conformity

According to 47CFR, Part 2 and 15, Class B Personal Computers and Peripherals; and/or CPU Boards and Power Supplies used with Class B Personal Computers

We: EPSON AMERICA, INC.
Located at: 3840 Kilroy Airport Way
MS: 3-13
Long Beach, CA 90806-2469
Telephone: (562) 290-5254

Declare under sole responsibility that the product identified herein, complies with 47CFR Part 2 and 15 of the FCC rules as a Class B digital device. Each product marketed, is identical to the representative unit tested and found to be compliant with the standards. Records maintained continue to reflect the equipment being produced can be expected to be within the variation accepted, due to quantity production and testing on a statistical basis as required by 47CFR §2.909. Operation is subject to the following two conditions: (1) this device may not cause harmful interference, and (2) this device must accept any interference received, including interference that may cause undesired operation.

Trade Name: EPSON
Type of Product: Projector
Model: EMP-7800
Marketing Name: PowerLite 7800p

FCC Compliance Statement

For United States Users

This equipment has been tested and found to comply with the limits for a Class B digital device, pursuant to Part 15 of the FCC Rules. These limits are designed to provide reasonable protection against harmful interference in a residential installation. This equipment generates, uses, and can radiate radio frequency energy and, if not installed and used in accordance with the instructions, may cause harmful interference to radio or television reception. However, there is no guarantee that interference will not occur in a particular installation. If this equipment does cause interference to radio and television reception, which can be determined by turning the equipment off and on, the user is encouraged to try to correct the interference by one or more of the following measures:

- Reorient or relocate the receiving antenna.
- Increase the separation between the equipment and receiver.
- Connect the equipment into an outlet on a circuit different from that to which the receiver is connected.
- Consult the dealer or an experienced radio/TV technician for help.

WARNING

The connection of a non-shielded equipment interface cable to this equipment will invalidate the FCC Certification of this device and may cause interference levels which exceed the limits established by the FCC for this equipment. It is the responsibility of the user to obtain and use a shielded equipment interface cable with this device. If this equipment has more than one interface connector, do not leave cables connected to unused interfaces. Changes or modifications not expressly approved by the manufacturer could void the user's authority to operate the equipment.

For Canadian Users

This Class B digital apparatus meets all requirements of the Canadian Interference-Causing Equipment Regulations.

Cet appareil numérique de la classe B respecte toutes les exigences du Règlement sur le matériel brouilleur du Canada.

Warranty

Epson America, Inc. Limited Warranty

Basic Two-Year Warranty and 90-Day Lamp Warranty

What Is Covered: Epson America, Inc. (“EPSON”) warrants to the first end user customer of the EPSON product enclosed with this limited warranty statement that the product, if purchased and used in the United States or Canada, conforms to the manufacturer’s specifications and will be free from defects in workmanship and materials for a period of two (2) years from the date of original purchase (except that the warranty period is 90 days for projector lamps).

What EPSON Will Do To Correct Problems: If you elect carry-in warranty service, please bring the product securely packaged in its original container or an equivalent, along with proof of the date of original purchase, to your EPSON Dealer or EPSON Customer Care Center. EPSON will, at its option, repair or replace on an exchange basis the defective unit, without charge for parts or labor. When warranty service involves the exchange of the product or of a part, the item replaced becomes EPSON property. The exchanged product or part may be new or previously repaired to the EPSON standard of quality. Exchange or replacement products or parts assume the remaining warranty period of the product covered by this limited warranty. However, each replacement lamp carries the limited 90-day warranty stated above.

What This Warranty Does Not Cover: This warranty covers only normal consumer use in the United States and Canada. For lamps, 24-hour-per-day use causes unusual strain and is not considered normal use. This warranty does not cover consumables (e.g., fuses), other than lamps. EPSON is not responsible for warranty service should the EPSON label or logo or the rating label or serial number be removed or should the product fail to be properly maintained or fail to function properly as a result of misuse, abuse, improper installation, neglect, improper shipping, damage caused by disasters such as fire, flood, and lightning, improper electrical current, software problems, interaction with non-EPSON products, or service other than by an EPSON Authorized Servicer. Postage, insurance, or shipping costs incurred in presenting your EPSON product for carry-in warranty service are your responsibility. If a claimed defect cannot be identified or reproduced in service, you will be held responsible for costs incurred.

THE WARRANTY AND REMEDY PROVIDED ABOVE ARE EXCLUSIVE AND IN LIEU OF ALL OTHER EXPRESS OR IMPLIED WARRANTIES INCLUDING, BUT NOT LIMITED TO, THE IMPLIED WARRANTIES OF MERCHANTABILITY OR FITNESS

FOR A PARTICULAR PURPOSE. SOME LAWS DO NOT ALLOW THE EXCLUSION OF IMPLIED WARRANTIES. IF THESE LAWS APPLY, THEN ALL EXPRESS AND IMPLIED WARRANTIES ARE LIMITED TO THE WARRANTY PERIOD IDENTIFIED ABOVE. UNLESS STATED HEREIN, ANY STATEMENTS OR REPRESENTATIONS MADE BY ANY OTHER PERSON OR FIRM ARE VOID. EXCEPT AS PROVIDED IN THIS WRITTEN WARRANTY, NEITHER EPSON AMERICA, INC. NOR ITS AFFILIATES SHALL BE LIABLE FOR ANY LOSS, INCONVENIENCE, OR DAMAGE, INCLUDING DIRECT, SPECIAL, INCIDENTAL OR CONSEQUENTIAL DAMAGES, RESULTING FROM THE USE OR INABILITY TO USE THE EPSON PRODUCT, WHETHER RESULTING FROM BREACH OF WARRANTY OR ANY OTHER LEGAL THEORY. IF THE REMEDY ABOVE FAILS, EPSON'S ENTIRE LIABILITY SHALL BE LIMITED TO A REFUND OF THE PRICE PAID FOR THE EPSON PRODUCTS COVERED BY THIS LIMITED WARRANTY.

In Canada, warranties include both warranties and conditions.

Some jurisdictions do not allow limitations on how long an implied warranty lasts and some jurisdictions do not allow the exclusion or limitation of incidental or consequential damages, so the above limitations and exclusions may not apply to you.

This warranty gives you specific legal rights, and you may also have other rights, which vary from jurisdiction to jurisdiction.

To locate the Authorized EPSON Servicer nearest you, call the EPSON ConnectionSM at (800) 637-7661 + PIN or (562) 276-4394 in the U.S. and (905) 709-3839 in Canada or write to: Epson America, Inc., P.O. Box 93012, Long Beach, CA 90809-3012.

Index

A

- A/V Mute, 59
- A/V Mute button, 51, 106
- About menu, 99, 105
- Accessories, 6, 113
- Adapter, Macintosh, 5, 6, 21
- Air filter
 - cleaning, 95 to 96
 - ordering, 6
 - replacing, 96 to 97
- Anti-theft device, 6, 9
- Aspect ratio, 117
- Audio
 - adjusting volume, 71
 - connecting equipment, 24 to 25
 - menu, 71
 - problems, troubleshooting, 111
 - turning off (using A/V Mute), 51
- Auto button, 39

B

- Bass, adjusting, 71
- Batteries, installing, 48
- Blank screen, 31 to 33
- Blurry image, 109
- Brightness, 117
- Brightness setting, 66

C

- Cables
 - BNC, 19
 - DVI, 6, 20
 - HDTV, 5
 - illustrations, 4
 - mouse, 22
 - ordering, 6
 - remote control cable set, 6
 - S-Video, 5, 6
 - VGA-to-component, 6, 17

- Capturing image, 57 to 58
- Carrying case, 6, 100
- Ceiling mount, 6, 115
- Cleaning
 - air filter, 95 to 96
 - lens, 94
 - projector case, 94
- Color
 - correcting with Wall Shot, 40 to 41
 - problems, 111
 - settings, 70
- Color Mode setting, 70
- Component video
 - cable, 10
 - selecting input signal, 13
- Composite (RCA) video cable, 10
- Computer
 - connecting to, 16 to 21
 - correcting images, 39
 - selecting source, 30
- Connecting projector
 - to a computer, 16 to 21
 - to audio equipment, 24 to 25
 - to video equipment, 10 to 15
- Contrast setting, 66

D

- Declaration of Conformity, 126
- Default settings, restoring, 65
- Desktop adapter, Macintosh, 5, 6, 21
- Distance from projector to screen, 8, 117
- Documentation, 2
- DVD player, connecting, 10 to 15
- DVI cable, 6, 20
- DVI port, connecting to, 20

E

Easy Management

- configuring the projector, 78 to 79
- monitoring the projector, 80 to 86
- problems, 112
- receiving e-mail alerts, 87 to 90
- system requirements, 76

Electrical specifications, 118

EMP Monitor

- changing monitoring interval, 86
- installing software, 76 to 77
- using, 80 to 86

EMP NetworkManager

- installing software, 76 to 77
- using, 87 to 91

Environmental specifications, 119

EPSON

- accessories, 6, 113
- presentation tips, 2
- PrivateLine Support, 2, 113
- technical support, 2, 113

E-Zoom button, 51 to 52

F

FCC compliance statement, 127

Filter, *see* Air filter

Focusing image, 34

H

HDTV images

- projecting, 5
- video formats, 121

Height of image, adjusting, 35

Help system, using, 102

Help, EPSON, 2, 113

HP OpenView, 75

I

ID setting, 60 to 61

iMac, connecting to, 5

Image

- adjusting, 34 to 39, 66 to 70
- capturing and saving in projector, 57 to 58
- correcting shape, 36 to 38, 69, 109
- fitting on screen, 108
- height, adjusting, 35
- positioning, 35
- problems with, 106 to 111
- projecting on walls, 40 to 41
- raising, 35
- selecting source, 11, 12, 13, 14, 15, 18, 19, 20, 30, 49 to 50, 72 to 73
- size and projection distance, 8, 117
- turning off (using A/V Mute), 51
- zooming, 34, 51 to 52

Input signal, selecting, 11, 12, 13, 14, 15, 18, 19, 20, 30, 49 to 50, 72 to 73

Installing projector, 115 to 116

K

Kensington anti-theft device, 6, 9

Keystone correction, 36 to 37, 69, 109, 117

L

Lamp

- number of hours used, 105
- ordering, 6
- replacing, 96 to 99
- specifications, 118
- status light, 103 to 104

Lamp timer, resetting, 99

Language setting, 74, 102

Laptop computer

- connecting to, 17 to 18
- display problems, 31 to 33, 106 to 107
- selecting image source, 30
- selecting source, 18, 19, 20

Lens

- cleaning, 94
- specifications, 117

Lights, status, 103 to 104

Logo, saving on projector, 57 to 59

M

Macintosh desktop adapter, 5, 6, 21

Manuals, 2

Menus

 About, 99, 105

 Audio, 71

 changing settings, 64 to 65

 default settings, restoring, 65

 User's Logo, 57 to 58

 using, 64 to 65

 Video, 66 to 68

Monitor, connecting external, 23

Monitoring projector

 EMP Monitor, 80 to 86

 HP OpenView, 75

 receiving e-mail alerts, 87 to 91

Mouse

 connecting cable for remote, 22

 using remote control as, 56

N

Network

 managing projector remotely, 75 to 91

 setting, 73, 83, 85, 89

New Hardware Wizard, 29

No Signal message, 31, 74, 106 to 107

Noise level, 117

Numeric keypad, using, 42

O

Optical aspect ratio, 117

Options for projector, 5 to 6

P

Password protection, 41 to 42

Picture source, selecting, 11, 12, 13, 14, 15, 18,

 19, 20, 30, 49 to 50, 72 to 73

Picture, *see* Image

P-in-P image, 52 to 53

Pointer tool, using, 54 to 55

Positioning

 image, 35

 projector, 8 to 9

Power

 button, 29

 specifications, 118

 status light, 29, 103 to 104

PowerPoint files, presenting, 22

Presentations

 computer, 16 to 22, 30, 39

 room conditions, 46

 tips and training, 2

 using the pointer tool, 54 to 55

 video, 10 to 15, 30

Presenters Online, 2, 113

PrivateLine Support, 2, 113

Problems

 color, 111

 image, 106 to 111

 monitoring projector, 112

 no signal, 31, 106 to 107

 remote control, 112

 sound, 111

 using on-screen help, 102

Projecting without screen, 40 to 41

Projection lamp, *see* Lamp

Projector

 carrying case, 6, 100

 cleaning, 94

 connections, *see* Connecting projector

 distance from screen, 8, 117

 ID, setting, 60

 installing, 115 to 116

 lamp specifications, 118

 monitoring remotely, 75 to 91

 multiple projectors, controlling, 60 to 61

 options, 6

 password protection, 41 to 42

 positioning, 8 to 9

 resolution, 117

 specifications, 117 to 119

 transporting, 100

 troubleshooting, 101 to 104

 turning off, 43

 turning on, 28 to 29

 unpacking, 4

 viewing information about, 105

Q

Quick Corner, using, 37 to 38

R

Raising image, 35

Rear-screen projection, 74, 115

Registration, 3

Remote control

- as wireless mouse, 56
- battery used, 118
- connecting cable for mouse, 22
- information, 125
- numeric keypad, using, 42
- problems, 112, 125
- range, 118
- replacing batteries, 48
- running slideshow with, 22
- setting ID, 61
- specifications, 118
- storing, 46
- troubleshooting, 112
- turning on, 46
- using, 45 to 61

Replacing lamp, 96 to 99

Resetting lamp timer, 99

Resetting menu options, 65

Resize image, 69

Resolution, 68, 117

S

Safety

- instructions, 123 to 124
- specifications, 119

Screen

- blank, 31 to 33
- distance from projector, 8
- ordering, 6

Screen image, *See* Image

Security

- Kensington lock, 6
- password protection, 41 to 42

Sleep mode, 43, 74

Software installation, 76 to 77

Sound

- adjusting, 71
- troubleshooting, 111

Source

- selecting, 30, 49 to 50, 72 to 73
- viewing, 105

Speaker, specifications, 117

Speakers, connecting, 25

Specifications

- brightness, 117
- dimensions, 118
- electrical, 118
- environmental, 119
- general, 117
- lamp, 118
- lens, 117
- remote control, 118
- resolution, 117
- safety, 119

Standby Mode setting, 73, 83, 85, 89

Startup screen, creating, 57 to 59

Status lights, 103 to 104

Support, EPSON, 2, 113

Support, *see* Technical support

S-Video cable, 5, 6

Switching picture source, 30, 49 to 50,
72 to 73

Synchronization, adjusting, 39, 110 to 111

System requirements, 76

T

Technical support, 2, 113

Temperature

- requirements, 119
- status light, 103 to 104

Tracking, adjusting, 39, 110 to 111

Transporting projector, 100

Treble, adjusting, 71

Troubleshooting

- blank screen, 31 to 33
 - cut-off image, 108
 - distorted image, 36 to 38
 - Easy Management, 112
 - image and sound problems, 106 to 111
 - no signal, 31, 106 to 107
 - projector problems, 101 to 104
 - remote control problems, 112
- Turning off picture (using A/V Mute), 51
- Turning off projector, 43

U

- Unpacking projector, 4
- USB cable, 4, 22
- User's Logo menu, 57 to 58

V

- VCR, connecting, 10 to 15
- Video
 - cables, 4, 5, 6, 10
 - connecting video equipment, 10 to 15
 - display settings, viewing, 105
 - formats, supported, 120 to 121
 - menu, 66 to 68
 - selecting source, 11, 12, 13, 30, 49 to 50,
72 to 73
- Volume, adjusting, 71

W

- Wall Shot, 40 to 41
- Warning lights, 103 to 104
- Warranty, 3, 128 to 129
- Wireless, mouse, 22, 56

Z

- Zoom ratio, 117
- Zooming image, 34, 51 to 52

Remote Control

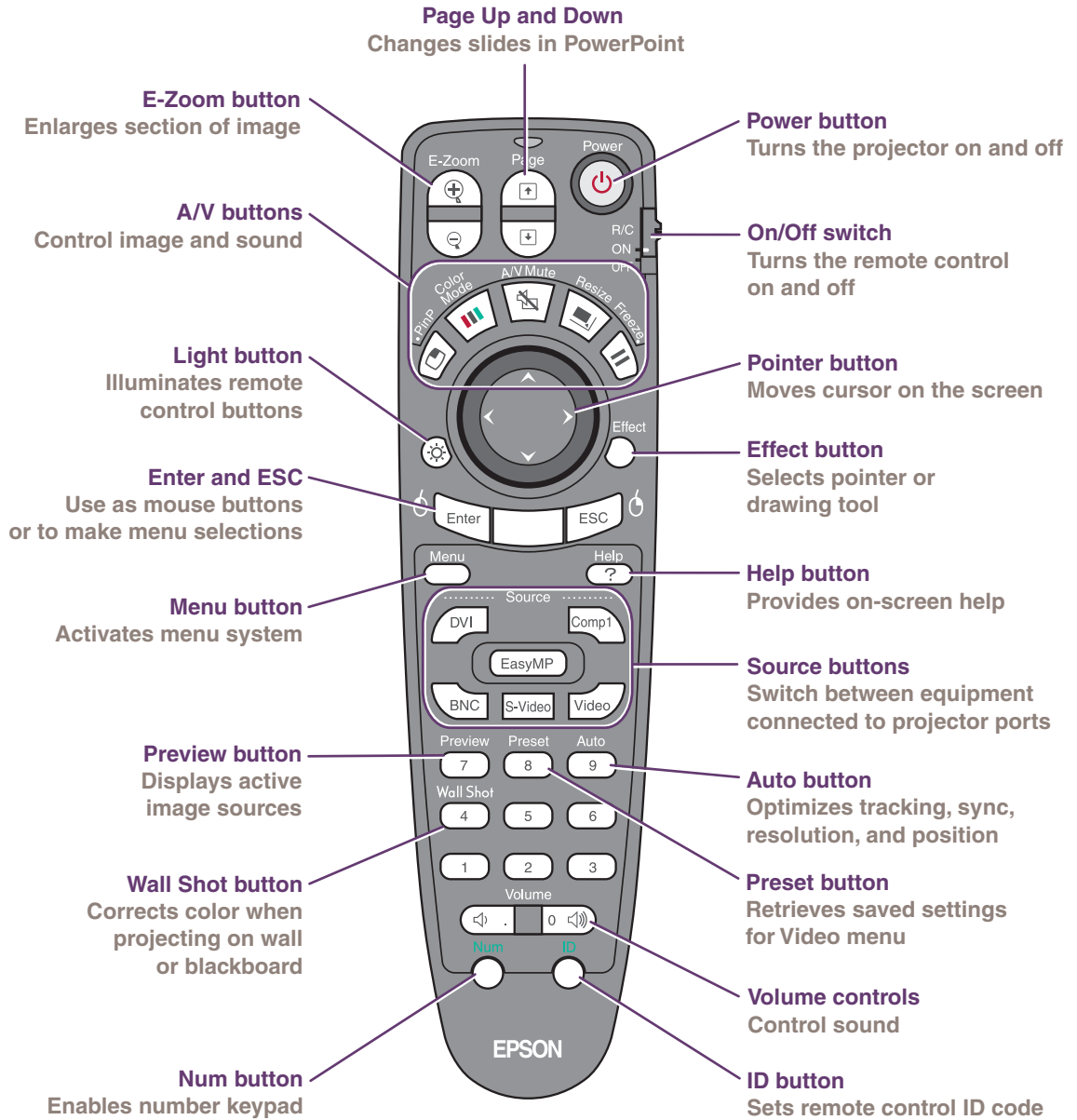

Front/Top

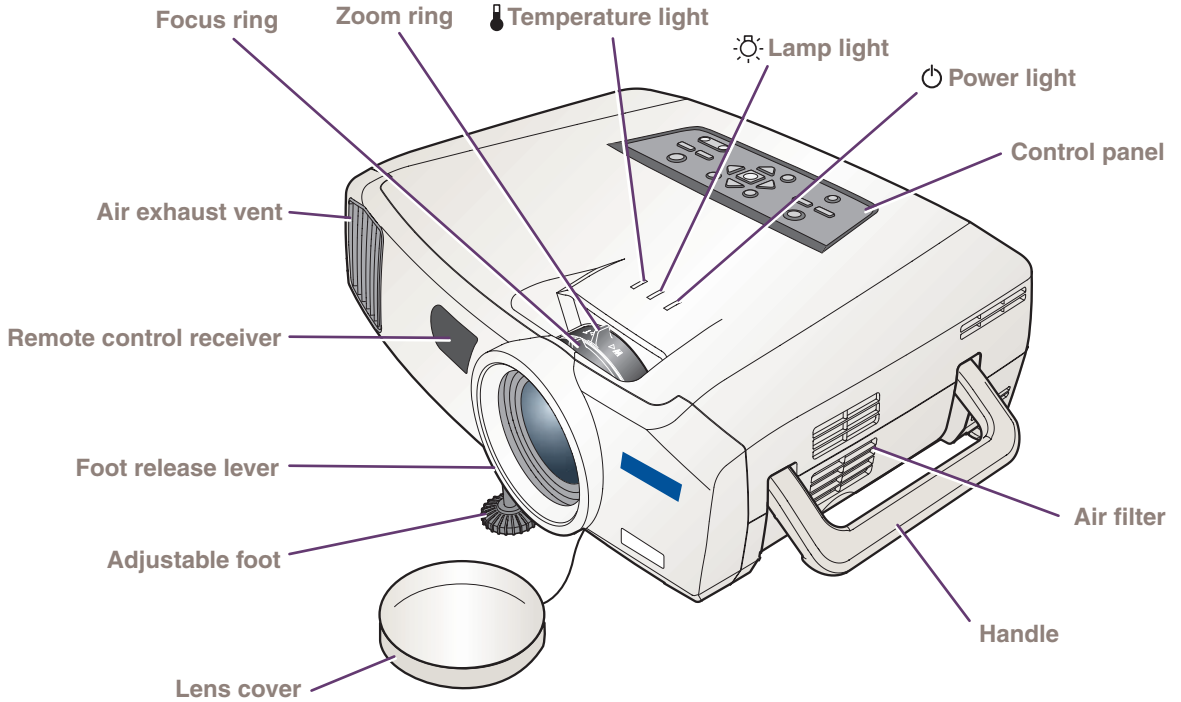

Back

